

# ENCODED\_

The Backend Data Experience

BLACK MARKET  
FLEA



moz://a



GRADUATE THESIS  
MA EXHIBITION AND EXPERIENCE DESIGN  
FASHION INSTITUTE OF TECHNOLOGY

DESIGN DEVELOPMENT PACKAGE

LYKA WILLIAMS

These drawings are not for construction. This is an unpublished and proprietary work protected under copyright, trade secret, and like laws of the United States and other countries. All rights reserved.

These materials may not be reproduced, displayed, distributed, nor may be the information therein be used or disclosed in whole or in part, without the express written permission of Marlyka Williams.

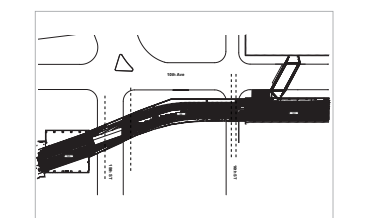

# DRAWING LIST

**EX.00.00 GENERAL**

- EX.00.01 Cover Page
- EX.00.02 Drawing List I
- EX.00.03 Symbols List

**EX.01.00 EXECUTIVE SUMMARY**

- EX.01.01 Thesis Statement
- EX.01.02 Conceptual Approach
- EX.01.03 Project Parameters
- EX.01.04 Client Overview
- EX.01.05 Exhibition Goals
- EX.01.06 Concept Diagram
- EX.01.07 Concept Floorplan
- EX.01.08 Exhibition Overview
- EX.01.09 Visitor Experience Diagram
- EX.01.10 Interpretative Approach
- EX.01.11 A00 Wayfinding I
- EX.01.12 A00 Wayfinding II
- EX.01.13 A01 Visitor Entry Render
- EX.01.14 A01 Visitor Entry Render II
- EX.01.15 A03 + A06 Render
- EX.01.16 A02 Exterior Render
- EX.01.17 A02 Interior Render
- EX.01.18 A05 Exterior Render
- EX.01.19 A05 Interior Render
- EX.01.20 B01 Render
- EX.01.21 B02 Render
- EX.01.22 B02 XR Experience Render
- EX.01.23 C01 Visitor Entry Render
- EX.01.24 C03 Exterior Render
- EX.01.25 C03 Activity Render
- EX.01.26 C03 Exterior Render
- EX.01.27 C06 Exterior Render
- EX.01.28 C06 Interior Render

**EX.02.00 SCHEDULES + LISTS**

- EX.02.01 Graphic Schedule I
- EX.02.02 Graphic Schedule II
- EX.02.03 Graphic Specifications
- EX.02.04 Finish Schedule I
- EX.02.05 Finish Schedule II
- EX.02.06 Lighting + Media Schedule
- EX.02.07 Object + Artifact Schedule I
- EX.02.08 Object + Artifact Schedule II

**EX.03.00 PLANS, SECTIONS + ELEVATIONS**

- EX.03.01 Site Location Plan
- EX.03.02 Site Plan
- EX.03.03 SA Dimensioned Floorplan
- EX.03.04 SB Dimensioned Floorplan
- EX.03.05 SC Dimensioned Floorplan
- EX.03.06 SA Graphic Location Plan
- EX.03.07 SB Graphic Location Plan
- EX.03.08 SC Graphic Location Plan
- EX.03.09 SA Material Plan
- EX.03.10 SB Material Plan
- EX.03.11 SC Material Plan
- EX.03.12 SA Media + Power Plan
- EX.03.13 SC Media + Power Plan
- EX.03.14 SA Object + Artifact Plan
- EX.03.15 SC Object + Artifact Plan
- EX.03.16 SA + SB Site Sections
- EX.03.17 SC Site Sections

**EX.04.00 GRAPHIC SYSTEMS**

- EX.04.01 Visual Communication Brief
- EX.04.02 Visual Identity Moodboard

**EX.04.00 GRAPHIC SYSTEMS**

- EX.04.03 Graphic Look + Feel
- EX.04.04 Exhibition Identity Logo
- EX.04.05 Visual Patterns + Prints
- EX.04.06 Color Palette
- EX.04.07 Exhibition Posters
- EX.04.08 Pre-Visit Strategy I
- EX.04.09 Pre-Visit Strategy II
- EX.04.10 Pre-Visit Strategy III
- EX.04.11 Exhibition Collateral I
- EX.04.12 Exhibition Collateral II
- EX.04.13 Docent Attire
- EX.04.14 Graphic Family

**EX.05.00 EXHIBITION DETAILING**

- EX.05.01 Wayfinding I
- EX.05.02 Wayfinding II
- EX.05.03 Introduction
- EX.05.04 Exhibit Content I
- EX.05.05 Exhibit Content II
- EX.05.06 Mural I
- EX.05.07 Mural II
- EX.05.08 Digital Media I
- EX.05.09 Digital Media II
- EX.05.10 Labels I
- EX.05.11 Labels II
- EX.05.12 Labels III
- EX.05.13 A06, C09 Technical Detail I
- EX.05.14 A06, C09 Technical Detail II
- EX.05.15 A06 + A02 Physical Model I
- EX.05.16 A06 + A02 Physical Model II
- EX.05.17 A02 Physical Model I



These drawings are not for construction. This is an unpublished and proprietary work protected under copyright, trade secret, and like laws of the United States and other countries. All rights reserved.

These materials may not be reproduced, displayed, distributed, nor may be the information therein be used or disclosed in whole or in part, without the express written permission of Marlyka Williams.

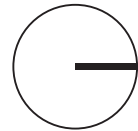
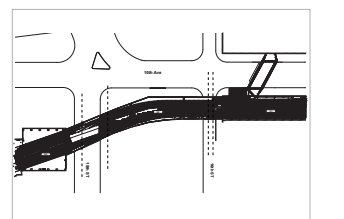

NORTH REFERENCE



EXHIBIT AREA TAG



SECTION CUT IDENTIFIER



ELEVATION DIRECTION SIGNIFIER



FINISHES REFERENCE



DRAWING IDENTIFIER  
ELEVATION  
Scale: 1/2" = 1'-0"

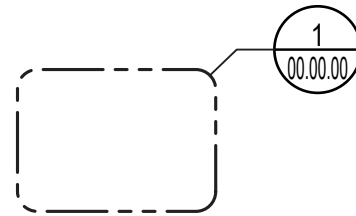

DETAIL CALL-OUT

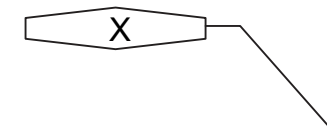

ARTIFACT REFERENCE

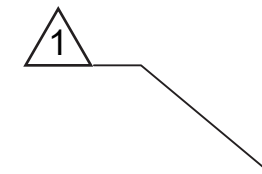

MEDIA REFERENCE

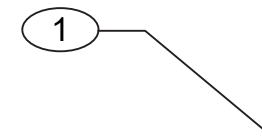

GRAPHICS REFERENCE



## EXECUTIVE SUMMARY

**PROJECT**

**ENCODED\_**  
The Backend Data Experience

**CLIENT**

**BLACK MARKET  
FLEA**

**PARTNERSHIP + SUPPORT**



**DISCLAIMER**

These drawings are not for construction. This is an unpublished and proprietary work protected under copyright, trade secret, and like laws of the United States and other countries. All rights reserved.

These materials may not be reproduced, displayed, distributed, nor may be the information therein be used or disclosed in whole or in part, without the express written permission of Marlyka Williams.

**KEY PLAN**

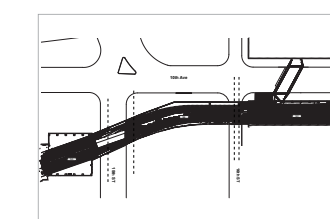

**DRAWN BY** MARLYKA WILLIAMS

**SCALE** NTS

**DATE** December 09, 2022

**DRAWING NAME**

Thesis Statement

**EX.01.01**

## THESIS STATEMENT

Generation Alpha is the first generation to be entirely born in the 21st century. Growing up in our society normalized by data-driven smart technology, they've lacked the ability to consent. Society has therefore developed a blurred notion of their expectations of privacy.

As this demographic rises in age and cements itself as the world's newest consumers, the retail industry must quickly evolve to offer a novel approach to consumer-brand connections, while balancing this cohort's desire for autonomy.

Experiential design that incorporates consumer choice via hyper-personalization into the physical world will cultivate long-term brand loyalty and promote regenerative financial conversions amongst this new generation.

# LYKA WILLIAMS

Exhibition & Experience Design

## FASHION INSTITUTE OF TECHNOLOGY

School of Graduate Studies  
272 West 27th St  
New York, NY 10011

### PROJECT

**ENCODED\_**  
The Backend Data Experience

### CLIENT

**BLACK MARKET  
FLEA**

### PARTNERSHIP + SUPPORT



### DISCLAIMER

These drawings are not for construction. This is an unpublished and proprietary work protected under copyright, trade secret, and like laws of the United States and other countries. All rights reserved.

These materials may not be reproduced, displayed, distributed, nor may be the information therein be used or disclosed in whole or in part, without the express written permission of Marlyka Williams.

### KEY PLAN

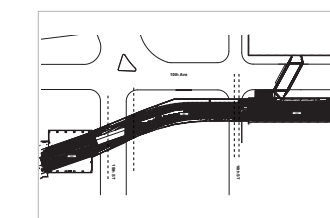

**DRAWN BY** MARLYKA WILLIAMS

**SCALE** NTS

**DATE** December 09, 2022

### DRAWING NAME

Conceptual Approach

**EX.01.02**

## CONCEPTUAL APPROACH

To empower consumers to weigh their data currency as they navigate the age and ease of digital personalization while in consideration of their personal data rights.

# LYKA WILLIAMS

Exhibition & Experience Design

## FASHION INSTITUTE OF TECHNOLOGY

School of Graduate Studies  
272 West 27th St  
New York, NY 10011

### PROJECT

**ENCODED\_**  
The Backend Data Experience

### CLIENT

**BLACK MARKET  
FLEA**

### PARTNERSHIP + SUPPORT



### DISCLAIMER

These drawings are not for construction. This is an unpublished and proprietary work protected under copyright, trade secret, and like laws of the United States and other countries. All rights reserved.

These materials may not be reproduced, displayed, distributed, nor may be the information therein be used or disclosed in whole or in part, without the express written permission of Marlyka Williams.

### KEY PLAN

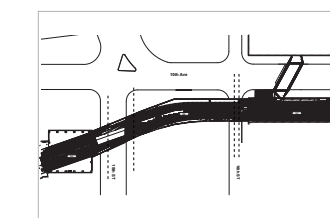

**DRAWN BY** MARLYKA WILLIAMS

**SCALE** NTS

**DATE** December 09, 2022

### DRAWING NAME

Project Parameters

# EX.01.03

## PROJECT PARAMETERS

### SUBJECT

Futures Literacy in Consumer Culture  
via Hyper-Personalization

### CLIENTS

Black Market Flea x Mozilla x Firefox X EPIC

### VENUE

The High Line  
3 venue locations along the elevated public rail  
park including: Chelsea Market Passage, Diller-von  
Furstenberg Sundeck, and 14th Street Passage.

### AUDIENCE

BIPOC Gen Alpha + Gen Z, Local Neighborhood  
Residents, Tourists + Other Park Visitors



**PROJECT**

**ENCODED\_**  
The Backend Data Experience

**CLIENT**

**BLACK MARKET  
FLEA**

**PARTNERSHIP + SUPPORT**



**DISCLAIMER**

These drawings are not for construction. This is an unpublished and proprietary work protected under copyright, trade secret, and like laws of the United States and other countries. All rights reserved.

These materials may not be reproduced, displayed, distributed, nor may be the information therein be used or disclosed in whole or in part, without the express written permission of Marlyka Williams.

**KEY PLAN**

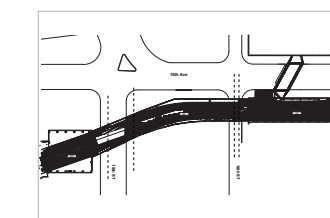

**DRAWN BY** MARLYKA WILLIAMS

**SCALE** NTS

**DATE** December 09, 2022

**DRAWING NAME**

Client Overview

**EX.01.04**

## CLIENT OVERVIEW

### BLACK MARKET FLEA

Black Market Flea is an exciting cultural experience that places Black businesses and creatives on a platform holding space for them to share their talents, passions, creations, and services with the community. Buying Black is the backbone of who we are. Our greatest desire is to be a catalyst for growth and equity amongst the many businesses that we hold space for. We have held this vision at the very core of who we are.

### MOZILLA

Mozilla puts people before profit, creating products, technologies and programs that make the internet healthier for everyone. Our mission is to ensure the Internet is a global public resource, open and accessible to all. An Internet that truly puts people first, where individuals can shape their own experience and are empowered, safe and independent.

### EPIC

EPIC is a public interest research center in Washington, DC seeking to protect privacy, freedom of expression, and democratic values in the information age. Our mission is to focus public attention on emerging privacy and civil liberties issues and to protect privacy. A few key areas we tackle include, but are not limited to, consumer privacy, Big Data, Cybersecurity, and Data Protection.

### FIREFOX

Firefox was created by Mozilla as a faster, more private alternative to browsers like Internet Explorer, and now Chrome. Today, our mission-driven company and volunteer community continue to put your privacy above all else through our Personal Data Promise: Take less. Keep it safe. No secrets. Your data, your web activity, and your life online are protected with Firefox.



These drawings are not for construction. This is an unpublished and proprietary work protected under copyright, trade secret, and like laws of the United States and other countries. All rights reserved.

These materials may not be reproduced, displayed, distributed, nor may be the information therein be used or disclosed in whole or in part, without the express written permission of Marlyka Williams.

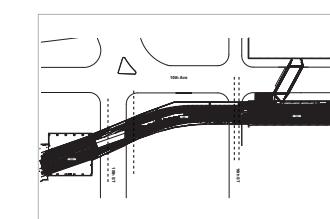

## PROJECT GOALS

### THIS EXHIBIT WILL . . .

Make the consumer the hero of the brand story/experience.

Highlight the power of consumer choice in recognizing that people do not buy goods and services—they buy relations, stories, and magic.

Distinguish the balance between the ultimate freedom of choice and the convenience of personalized, algorithmic decision-making.

Re-imagine the historical role of public-facing flea markets within the context of omnichannel consumer experiences to create a modern, dual-connected brand and consumer relationship.

Amplify the power of the black dollar via black consumerism through Black Market Flea's introduction to the New York market, recognizing that it is more than a social space, but it is in fact a catalyst for growth and equity amongst the many businesses for which they hold space.

## EXPERIENCE GOALS

### VISITORS WILL ENGAGE IN. . .

Navigating the convenience of algorithmic data mining vs. consumer privacy.

Consumer power and its collective ability to reinvest in economic prosperity, understanding that "to whom you give your money, is whom you give your power."

How personal data insights are transmitted and collected to offer a more personalized brand experience.

Understanding one's digital traces and the backend interactions that occur through hyper-personalization within the everyday, digital ecosystem.

## EDUCATION GOALS

### VISITORS WILL LEARN. . .

How to transform every, environmental retail moment with real-time, algorithmic decision-making.

How to interact through seamless, AI-enabled experience touchpoints, catering to their context-driven, consumer choices.

How to engage in kinetic role play navigating as one's encoded data set within the Metaverse among our traditional day-to-day routine.

How to engage in mixed media integrations, encouraging more informed decision-making as it concerns consumer digital data rights.

PROJECT

ENCODED\_  
The Backend Data Experience

CLIENT

BLACK MARKET FLEA

PARTNERSHIP + SUPPORT



DISCLAIMER

These drawings are not for construction. This is an unpublished and proprietary work protected under copyright, trade secret, and like laws of the United States and other countries. All rights reserved.

These materials may not be reproduced, displayed, distributed, nor may be the information therein be used or disclosed in whole or in part, without the express written permission of Marlyka Williams.

KEY PLAN

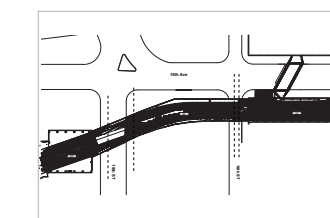

DRAWN BY MARLYKA WILLIAMS

SCALE NTS

DATE December 09, 2022

DRAWING NAME

Concept Diagram

EX.01.06

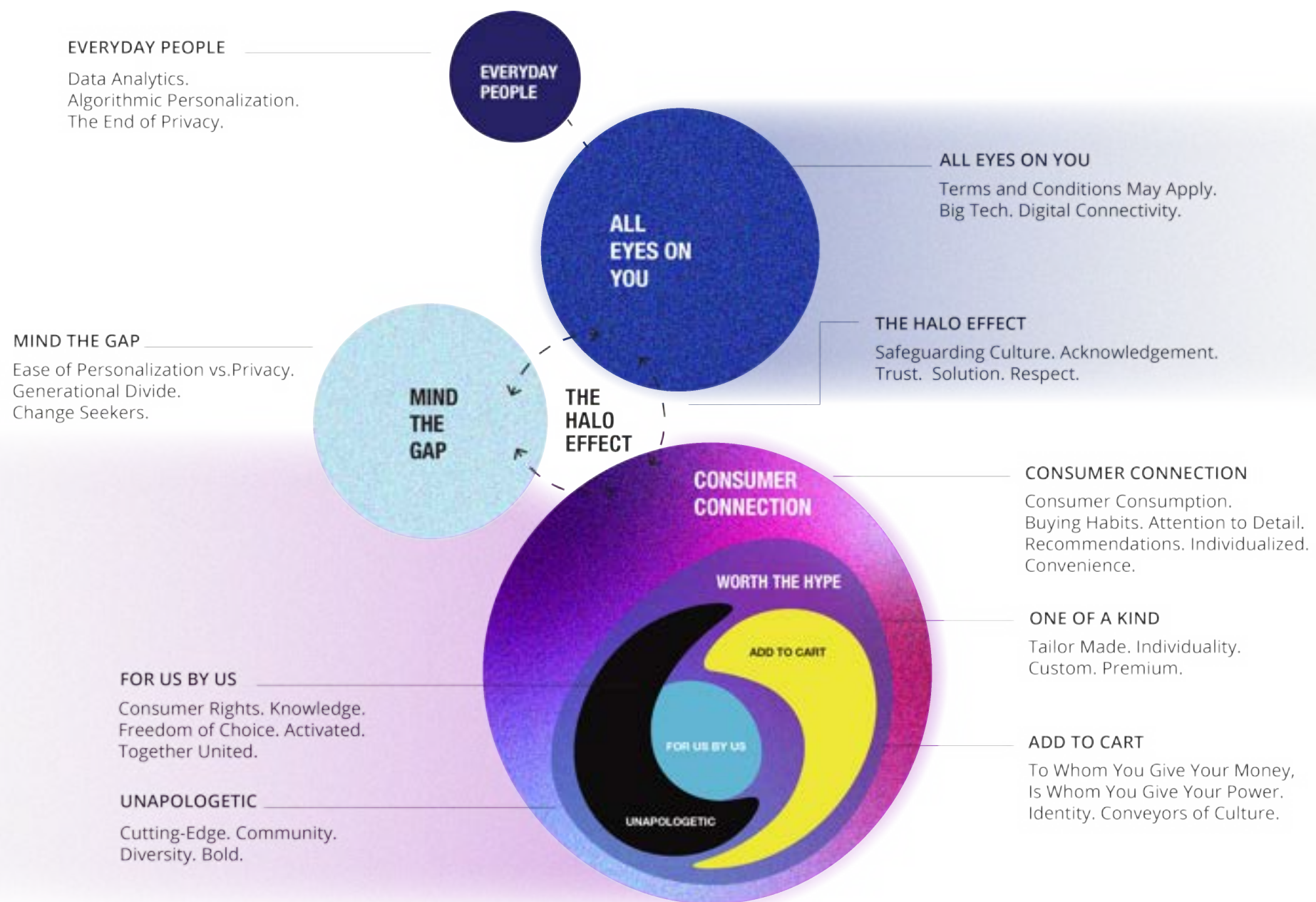

These drawings are not for construction. This is an unpublished and proprietary work protected under copyright, trade secret, and like laws of the United States and other countries. All rights reserved.

These materials may not be reproduced, displayed, distributed, nor may be the information therein be used or disclosed in whole or in part, without the express written permission of Marlyka Williams.

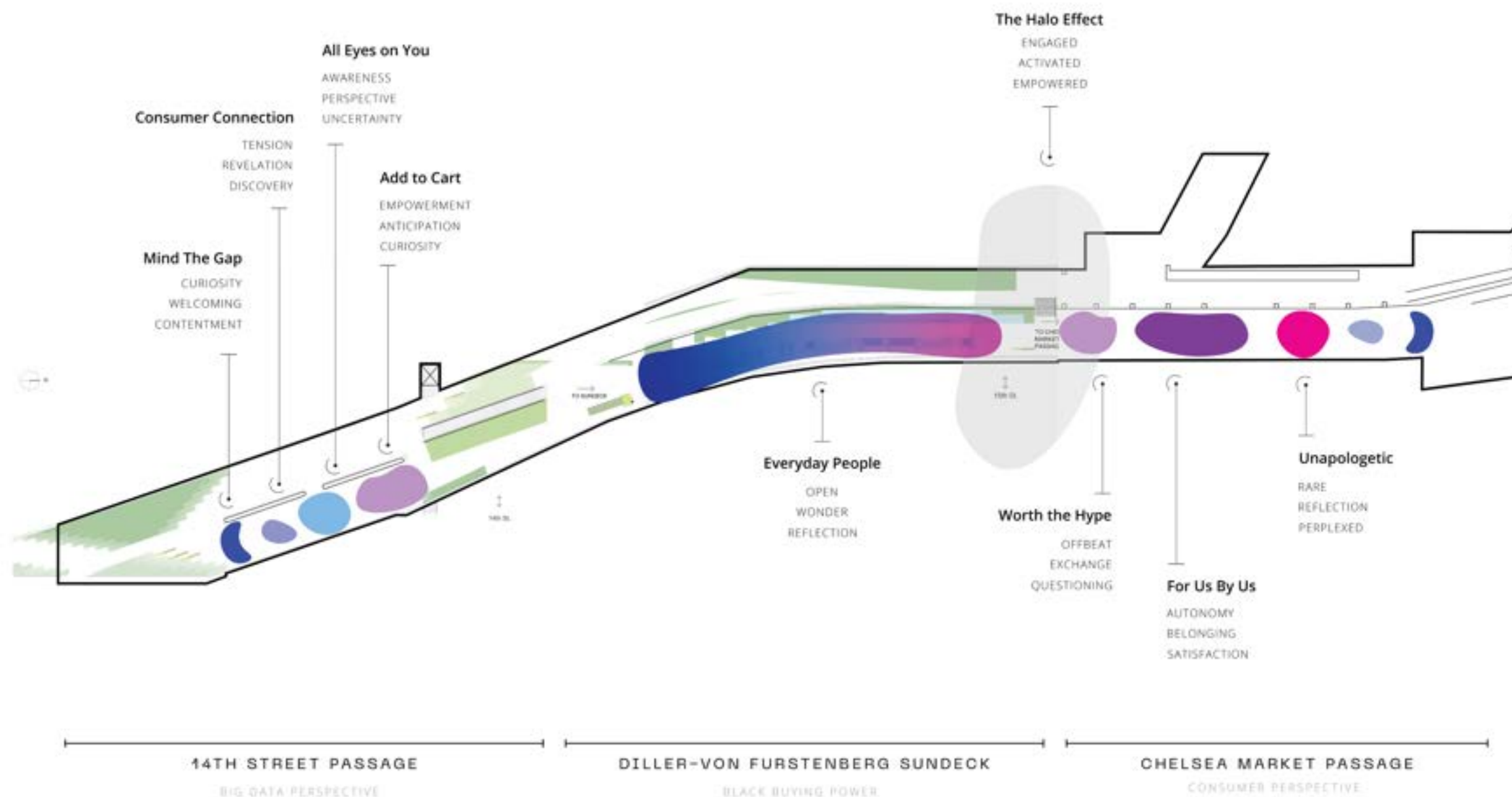
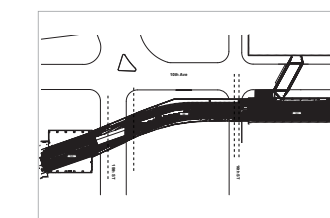

# LYKA WILLIAMS

Exhibition & Experience Design

## FASHION INSTITUTE OF TECHNOLOGY

School of Graduate Studies  
272 West 27th St  
New York, NY 10011

### PROJECT

**ENCODED\_**  
The Backend Data Experience

### CLIENT

**BLACK MARKET  
FLEA**

### PARTNERSHIP + SUPPORT



### DISCLAIMER

These drawings are not for construction. This is an unpublished and proprietary work protected under copyright, trade secret, and like laws of the United States and other countries. All rights reserved.

These materials may not be reproduced, displayed, distributed, nor may be the information therein be used or disclosed in whole or in part, without the express written permission of Marlyka Williams.

### KEY PLAN

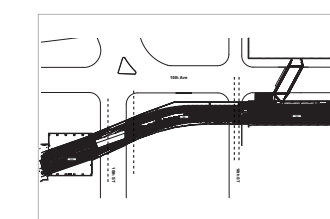

**DRAWN BY** MARLYKA WILLIAMS

**SCALE** NTS

**DATE** December 09, 2022

**DRAWING NAME**

Exhibition Overview

# EX.01.08

## EXHIBITION OVERVIEW

This project aims to add awareness and discovery to the consumer experience by understanding the history of the digital age and pop-up marketing, as well as, their future by prioritizing personalized interactions that foster unique customer experiences through leveraging individual data insights.

Presenting the allure and ease of algorithmic personalization juxtaposed against personal digital privacy, this experience empowers visitors to unapologetically reclaim their digital narrative as a means to safeguard the very aspect of their future customer experiences. Through interactive, on-site programming and scalable mixed media integrations, visitors serve as conveyors of today's culture, educated on what is unconsciously relinquished through their participation in data analytic touch points.

By exploring multiple perspectives on individual's blind consent to the harnessing of their data insights, it weighs the appeal of hyper-personalization versus that of the end of privacy. Visitors are therefore activated on the value of their collective buying power, becoming more cognizant of the enjoyment of these technological advances and affiliated opportunities to maintain data integrity, security, and privacy.

# LYKA WILLIAMS

Exhibition & Experience Design

## FASHION INSTITUTE OF TECHNOLOGY

School of Graduate Studies  
272 West 27th St  
New York, NY 10011

### PROJECT

**ENCODED\_**  
The Backend Data Experience

### CLIENT

**BLACK MARKET FLEA**

### PARTNERSHIP + SUPPORT



### DISCLAIMER

These drawings are not for construction. This is an unpublished and proprietary work protected under copyright, trade secret, and like laws of the United States and other countries. All rights reserved.

These materials may not be reproduced, displayed, distributed, nor may be the information therein be used or disclosed in whole or in part, without the express written permission of Marlyka Williams.

### KEY PLAN

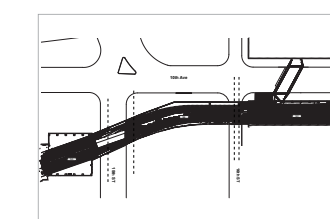

**DRAWN BY** MARLYKA WILLIAMS

**SCALE** NTS

**DATE** December 09, 2022

### DRAWING NAME

Visitor Experience Diagram

# EX.01.09

**CONSUMER**  
PERSPECTIVE

**WHEN PRIVACY ISN'T POLICY**  
Hyper-personalization  
through rose colored lenses



**BIG TECH + SMALL BUSINESS**

PERSPECTIVE

**TERMS AND CONDITIONS APPLY**

The backend experience  
of data collection

**PROJECT**

**ENCODED\_**  
The Backend Data Experience

**CLIENT**

**BLACK MARKET  
FLEA**

**PARTNERSHIP + SUPPORT**



**DISCLAIMER**

These drawings are not for construction. This is an unpublished and proprietary work protected under copyright, trade secret, and like laws of the United States and other countries. All rights reserved.

These materials may not be reproduced, displayed, distributed, nor may be the information therein be used or disclosed in whole or in part, without the express written permission of Marlyka Williams.

**KEY PLAN**

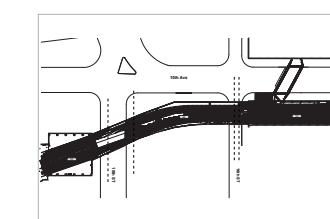

**DRAWN BY** MARLYKA WILLIAMS

**SCALE** NTS

**DATE** December 09, 2022

**DRAWING NAME**

Interpretive Approach

**EX.01.10**

## INTERPRETIVE APPROACH

Upon entry, the visitor journey begins with a choice, prompting attendees to “Opt-In” or “Opt-Out” of allowing their activity to be digitally tracked. Attendees who “Opt-In” receive the “Heightened” exhibition experience, becoming affiliated by their digital identity or "encoded user number," which grants them access to a hyper-personalized, recommendation-based shopping experience. Whereas visitors who “Opted-out,” experience the “Core” exhibit experience, fostering an exploratory-based shopping experience.

In both tiers, visitors navigate the double-ended experience featuring the relationship between Big Tech companies, consumers, and private data. Through the linear exploration of these viewpoints, visitors engage with physical objects, gamified mixed media, and first-person narratives, fostering the awareness of the many touchpoints of the passive collection of smartphone data and individual data insights derived therefrom hyper-personalized content.

The experience culminates in granting autonomy to black consumers, highlighting the freedom to decide how private data and information ought to be used and shared. Consumers hold a lot of power; thus, if we demand that privacy is embedded into the services we use, companies will understand that privacy is a feature, not a bug.

# LYKA WILLIAMS

Exhibition & Experience Design

## FASHION INSTITUTE OF TECHNOLOGY

School of Graduate Studies  
272 West 27th St  
New York, NY 10011

### PROJECT

## ENCODED\_

The Backend Data Experience

### CLIENT

## BLACK MARKET FLEA

### PARTNERSHIP + SUPPORT



### DISCLAIMER

These drawings are not for construction. This is an unpublished and proprietary work protected under copyright, trade secret, and like laws of the United States and other countries. All rights reserved.

These materials may not be reproduced, displayed, distributed, nor may be the information therein be used or disclosed in whole or in part, without the express written permission of Marlyka Williams.

### KEY PLAN

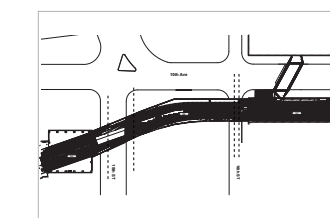

**DRAWN BY** MARLYKA WILLIAMS

**SCALE** NTS

**DATE** December 09, 2022

**DRAWING NAME**

A00 Wayfinding I

# EX.01.11



## DIRECTIONAL WAYFINDING

The visitor journey begins with an introduction to the exhibit's presence along the High Line via on-site wayfinding dispersed throughout key circulation zones. Freestanding directional navigators reinforce the intended travel path along visitor's vertical visual plain.



# LYKA WILLIAMS

Exhibition & Experience Design

## FASHION INSTITUTE OF TECHNOLOGY

School of Graduate Studies  
272 West 27th St  
New York, NY 10011

### PROJECT

**ENCODED\_**  
The Backend Data Experience

### CLIENT

**BLACK MARKET  
FLEA**

### PARTNERSHIP + SUPPORT



### DISCLAIMER

These drawings are not for construction. This is an unpublished and proprietary work protected under copyright, trade secret, and like laws of the United States and other countries. All rights reserved.

These materials may not be reproduced, displayed, distributed, nor may be the information therein be used or disclosed in whole or in part, without the express written permission of Marlyka Williams.

### KEY PLAN

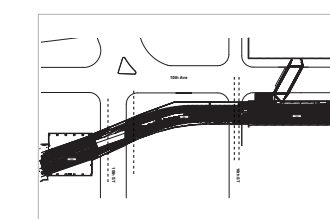

**DRAWN BY** MARLYKA WILLIAMS

**SCALE** NTS

**DATE** December 09, 2022

**DRAWING NAME**

A00 Wayfinding II

# EX.01.12



## DIRECTIONAL WAYFINDING

Ground adhered floor graphics provide additional navigation which aid in capturing visitors attention along the horizontal plain.

# LYKA WILLIAMS

Exhibition & Experience Design

## FASHION INSTITUTE OF TECHNOLOGY

School of Graduate Studies  
272 West 27th St  
New York, NY 10011

### PROJECT

**ENCODED\_**  
The Backend Data Experience

### CLIENT

**BLACK MARKET  
FLEA**

### PARTNERSHIP + SUPPORT



### DISCLAIMER

These drawings are not for construction. This is an unpublished and proprietary work protected under copyright, trade secret, and like laws of the United States and other countries. All rights reserved.

These materials may not be reproduced, displayed, distributed, nor may be the information therein be used or disclosed in whole or in part, without the express written permission of Marlyka Williams.

### KEY PLAN

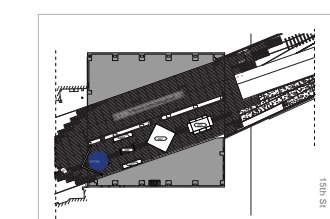

**DRAWN BY** MARLYKA WILLIAMS

**SCALE** NTS

**DATE** December 09, 2022

### DRAWING NAME

A01 Visitor Entry Render

# EX.01.13



## MIND THE GAP

Upon arrival, visitors are met by an introductory question, enabled digitally as a geo-location triggered pop-up on their personal devices and physically, as displayed on the exhibit's entry walls. To begin the experience, visitors must choose whether they would like to "opt-in" or "opt-out" of allowing ENCODED to track their movement and interactions both within the exhibition and across affiliated vendor websites.

# LYKA WILLIAMS

Exhibition & Experience Design

## FASHION INSTITUTE OF TECHNOLOGY

School of Graduate Studies  
272 West 27th St  
New York, NY 10011

### PROJECT

## ENCODED\_

The Backend Data Experience

### CLIENT

## BLACK MARKET FLEA

### PARTNERSHIP + SUPPORT



### DISCLAIMER

These drawings are not for construction. This is an unpublished and proprietary work protected under copyright, trade secret, and like laws of the United States and other countries. All rights reserved.

These materials may not be reproduced, displayed, distributed, nor may be the information therein be used or disclosed in whole or in part, without the express written permission of Marlyka Williams.

### KEY PLAN

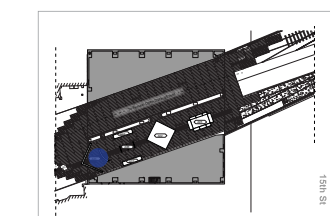

DRAWN BY MARLYKA WILLIAMS

SCALE NTS

DATE December 09, 2022

### DRAWING NAME

A01 Visitor Entry Render II

# EX.01.14

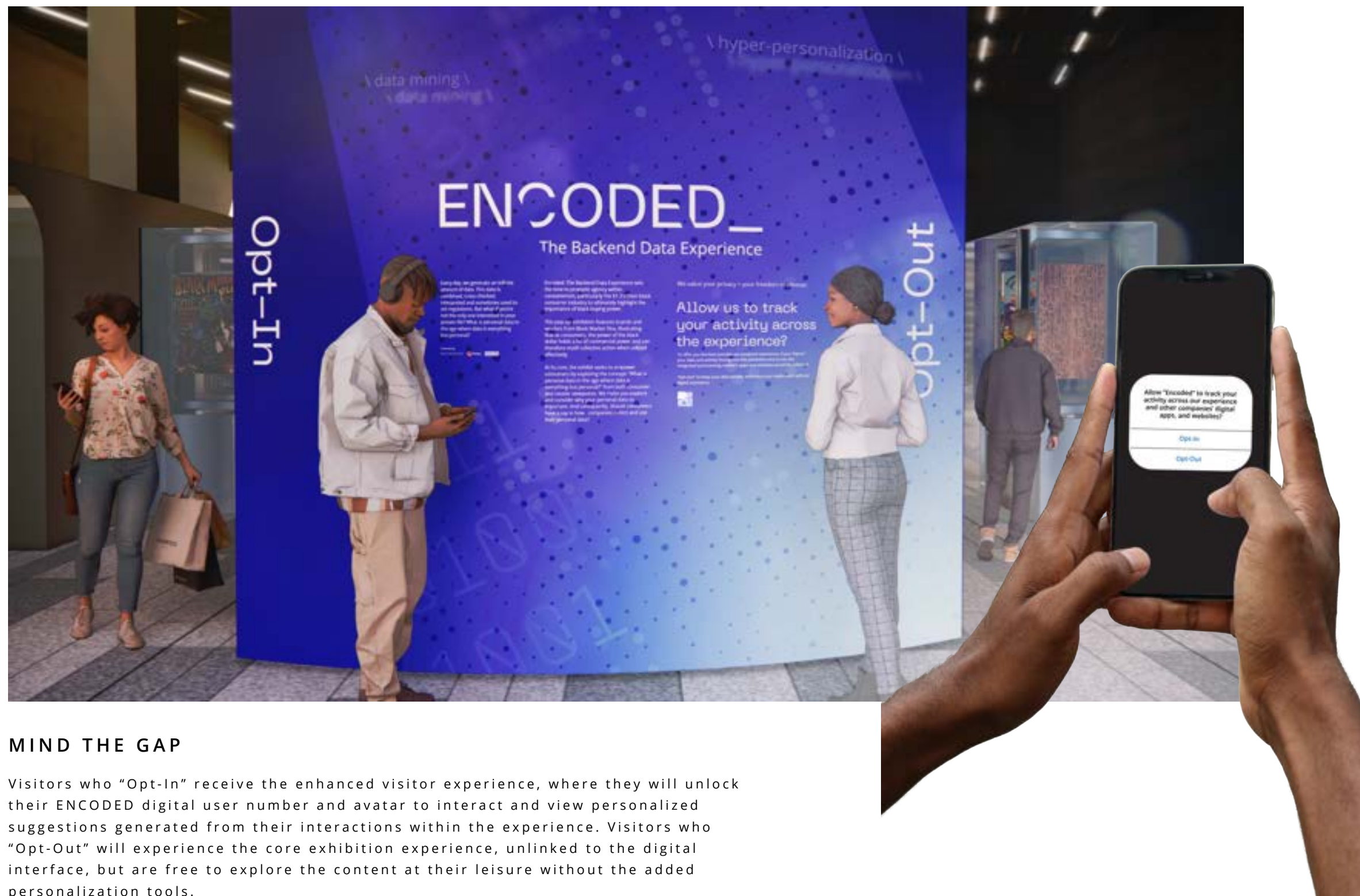

## MIND THE GAP

Visitors who "Opt-In" receive the enhanced visitor experience, where they will unlock their ENCODED digital user number and avatar to interact and view personalized suggestions generated from their interactions within the experience. Visitors who "Opt-Out" will experience the core exhibition experience, unlinked to the digital interface, but are free to explore the content at their leisure without the added personalization tools.

# LYKA WILLIAMS

Exhibition & Experience Design

## FASHION INSTITUTE OF TECHNOLOGY

School of Graduate Studies  
272 West 27th St  
New York, NY 10011

### PROJECT

# ENCODED\_

The Backend Data Experience

### CLIENT

# BLACK MARKET FLEA

### PARTNERSHIP + SUPPORT



### DISCLAIMER

These drawings are not for construction. This is an unpublished and proprietary work protected under copyright, trade secret, and like laws of the United States and other countries. All rights reserved.

These materials may not be reproduced, displayed, distributed, nor may be the information therein be used or disclosed in whole or in part, without the express written permission of Marlyka Williams.

### KEY PLAN

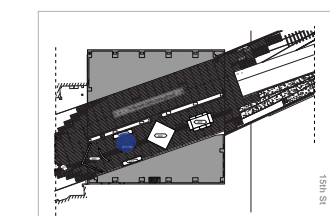

**DRAWN BY** MARLYKA WILLIAMS

**SCALE** NTS

**DATE** December 09, 2022

**DRAWING NAME**

A03 + A06 Render

# EX.01.15



## CONSUMER CONNECTION

Visitors gain a deeper understanding of the backend digital process from central displays where they can move throughout each panel to learn key topics that encapsulate data-driven personalization. Outlined call-outs of both “Big Tech” and “Consumer” perspectives flank each outer panel. The central most tier displays an encased featured fashion piece from an affiliated Black Market Flea vendor.

# LYKA WILLIAMS

Exhibition & Experience Design

## FASHION INSTITUTE OF TECHNOLOGY

School of Graduate Studies  
272 West 27th St  
New York, NY 10011

### PROJECT

**ENCODED\_**  
The Backend Data Experience

### CLIENT

**BLACK MARKET  
FLEA**

### PARTNERSHIP + SUPPORT



### DISCLAIMER

These drawings are not for construction. This is an unpublished and proprietary work protected under copyright, trade secret, and like laws of the United States and other countries. All rights reserved.

These materials may not be reproduced, displayed, distributed, nor may be the information therein be used or disclosed in whole or in part, without the express written permission of Marlyka Williams.

### KEY PLAN

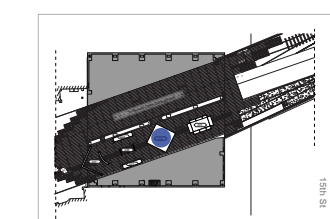

**DRAWN BY** MARLYKA WILLIAMS

**SCALE** NTS

**DATE** December 09, 2022

**DRAWING NAME**

A02 Exterior Render

# EX.01.16



## ALL EYES ON YOU

Visitors are then introduced to the stories of Black Market Flea vendors through interior and exterior rear screen projections of looped video content.

# LYKA WILLIAMS

Exhibition & Experience Design

## FASHION INSTITUTE OF TECHNOLOGY

School of Graduate Studies  
272 West 27th St  
New York, NY 10011

### PROJECT

**ENCODED\_**  
The Backend Data Experience

### CLIENT

**BLACK MARKET  
FLEA**

### PARTNERSHIP + SUPPORT



### DISCLAIMER

These drawings are not for construction. This is an unpublished and proprietary work protected under copyright, trade secret, and like laws of the United States and other countries. All rights reserved.

These materials may not be reproduced, displayed, distributed, nor may be the information therein be used or disclosed in whole or in part, without the express written permission of Marlyka Williams.

### KEY PLAN

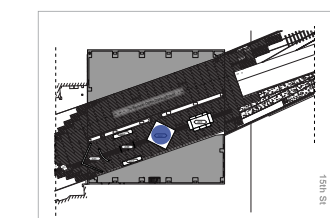

**DRAWN BY** MARLYKA WILLIAMS

**SCALE** NTS

**DATE** December 09, 2022

**DRAWING NAME**

A02 Interior Render

# EX.01.17



## ALL EYES ON YOU

Here, they can watch and hear first-person perspectives from small business owners relaying why they utilize algorithmic personalization to offer better online and in-store shopping experiences to consumers. On days of Black Market Flea events, visitors will be able to watch a live-stream of vendor interviews and event clips.

# LYKA WILLIAMS

Exhibition & Experience Design

## FASHION INSTITUTE OF TECHNOLOGY

School of Graduate Studies  
272 West 27th St  
New York, NY 10011

### PROJECT

## ENCODED\_

The Backend Data Experience

### CLIENT

## BLACK MARKET FLEA

### PARTNERSHIP + SUPPORT



### DISCLAIMER

These drawings are not for construction. This is an unpublished and proprietary work protected under copyright, trade secret, and like laws of the United States and other countries. All rights reserved.

These materials may not be reproduced, displayed, distributed, nor may be the information therein be used or disclosed in whole or in part, without the express written permission of Marlyka Williams.

### KEY PLAN

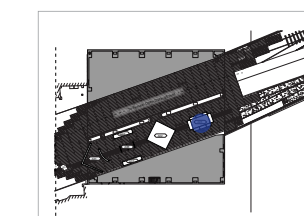

DRAWN BY MARLYKA WILLIAMS

SCALE NTS

DATE December 09, 2022

### DRAWING NAME

A05 Exterior Render

# EX.01.18



## ADD TO CART

As visitors exit, they arrive at the last exhibition zone within 14th St. Passage. They are met by shoppable fashion, ceramic, and lifestyle pieces from signature Black Market Flea brands along the exterior and interior of the structure encased within infinity mirror display cases.

# LYKA WILLIAMS

Exhibition & Experience Design

## FASHION INSTITUTE OF TECHNOLOGY

School of Graduate Studies  
272 West 27th St  
New York, NY 10011

### PROJECT

## ENCODED\_

The Backend Data Experience

### CLIENT

## BLACK MARKET FLEA

### PARTNERSHIP + SUPPORT



### DISCLAIMER

These drawings are not for construction. This is an unpublished and proprietary work protected under copyright, trade secret, and like laws of the United States and other countries. All rights reserved.

These materials may not be reproduced, displayed, distributed, nor may be the information therein be used or disclosed in whole or in part, without the express written permission of Marlyka Williams.

### KEY PLAN

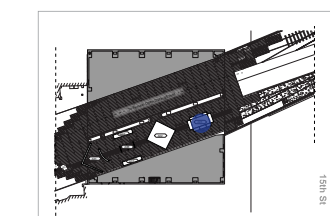

DRAWN BY MARLYKA WILLIAMS

SCALE NTS

DATE December 09, 2022

DRAWING NAME

A05 Interior Render

# EX.01.19



## ADD TO CART

Printed content labels capture each product's scannable QR codes. All visitors can scan to view additional vendor and product information; however, visitors who "Opted-In" receive the additional opportunity to unlock and rate personalized styling recommendations offered for products they are interested in.



# LYKA WILLIAMS

Exhibition & Experience Design

## FASHION INSTITUTE OF TECHNOLOGY

School of Graduate Studies  
272 West 27th St  
New York, NY 10011

### PROJECT

## ENCODED\_

The Backend Data Experience

### CLIENT

## BLACK MARKET FLEA

### PARTNERSHIP + SUPPORT



### DISCLAIMER

These drawings are not for construction. This is an unpublished and proprietary work protected under copyright, trade secret, and like laws of the United States and other countries. All rights reserved.

These materials may not be reproduced, displayed, distributed, nor may be the information therein be used or disclosed in whole or in part, without the express written permission of Marlyka Williams.

### KEY PLAN

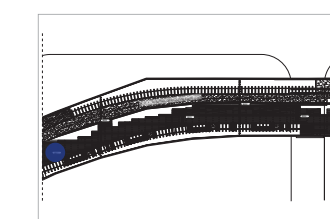

**DRAWN BY** MARLYKA WILLIAMS

**SCALE** NTS

**DATE** December 09, 2022

**DRAWING NAME**

B01 Render

# EX.01.20



## EVERYDAY PEOPLE

Continuing the visitor journey along the Diller Von Furstenberg Sundeck, visitors see large sculptural portals housing acrylic graphic content displays. Each panel features sample provocative questions alluding to the relationship between consumers, companies, technology and private data. Each panel integrates QR codes linked to the microsite where visitors can reveal the answers and learn more about each posed question.

# LYKA WILLIAMS

Exhibition & Experience Design

## FASHION INSTITUTE OF TECHNOLOGY

School of Graduate Studies  
272 West 27th St  
New York, NY 10011

### PROJECT

# ENCODED\_

The Backend Data Experience

### CLIENT

# BLACK MARKET FLEA

### PARTNERSHIP + SUPPORT



### DISCLAIMER

These drawings are not for construction. This is an unpublished and proprietary work protected under copyright, trade secret, and like laws of the United States and other countries. All rights reserved.

These materials may not be reproduced, displayed, distributed, nor may be the information therein be used or disclosed in whole or in part, without the express written permission of Marlyka Williams.

### KEY PLAN

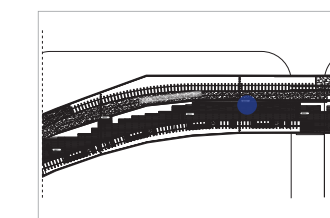

DRAWN BY MARLYKA WILLIAMS

SCALE NTS

DATE December 09, 2022

### DRAWING NAME

B02 Render

# EX.01.21



## THE HALO EFFECT

Nearest the center of the sundeck, visitors can utilize their mobile devices to view architectural mixed reality (XR) content linked to the immediate surrounding facades through a sculptural mirrored art display as entry point.

# LYKA WILLIAMS

Exhibition & Experience Design

## FASHION INSTITUTE OF TECHNOLOGY

School of Graduate Studies  
272 West 27th St  
New York, NY 10011

### PROJECT

## ENCODED\_

The Backend Data Experience

### CLIENT

## BLACK MARKET FLEA

### PARTNERSHIP + SUPPORT



### DISCLAIMER

These drawings are not for construction. This is an unpublished and proprietary work protected under copyright, trade secret, and like laws of the United States and other countries. All rights reserved.

These materials may not be reproduced, displayed, distributed, nor may be the information therein be used or disclosed in whole or in part, without the express written permission of Marlyka Williams.

### KEY PLAN

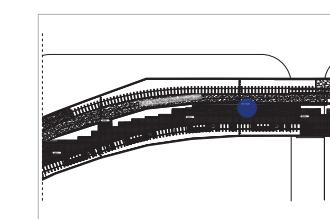

DRAWN BY MARLYKA WILLIAMS

SCALE NTS

DATE December 09, 2022

DRAWING NAME

B02 XR Experience Render

# EX.01.22

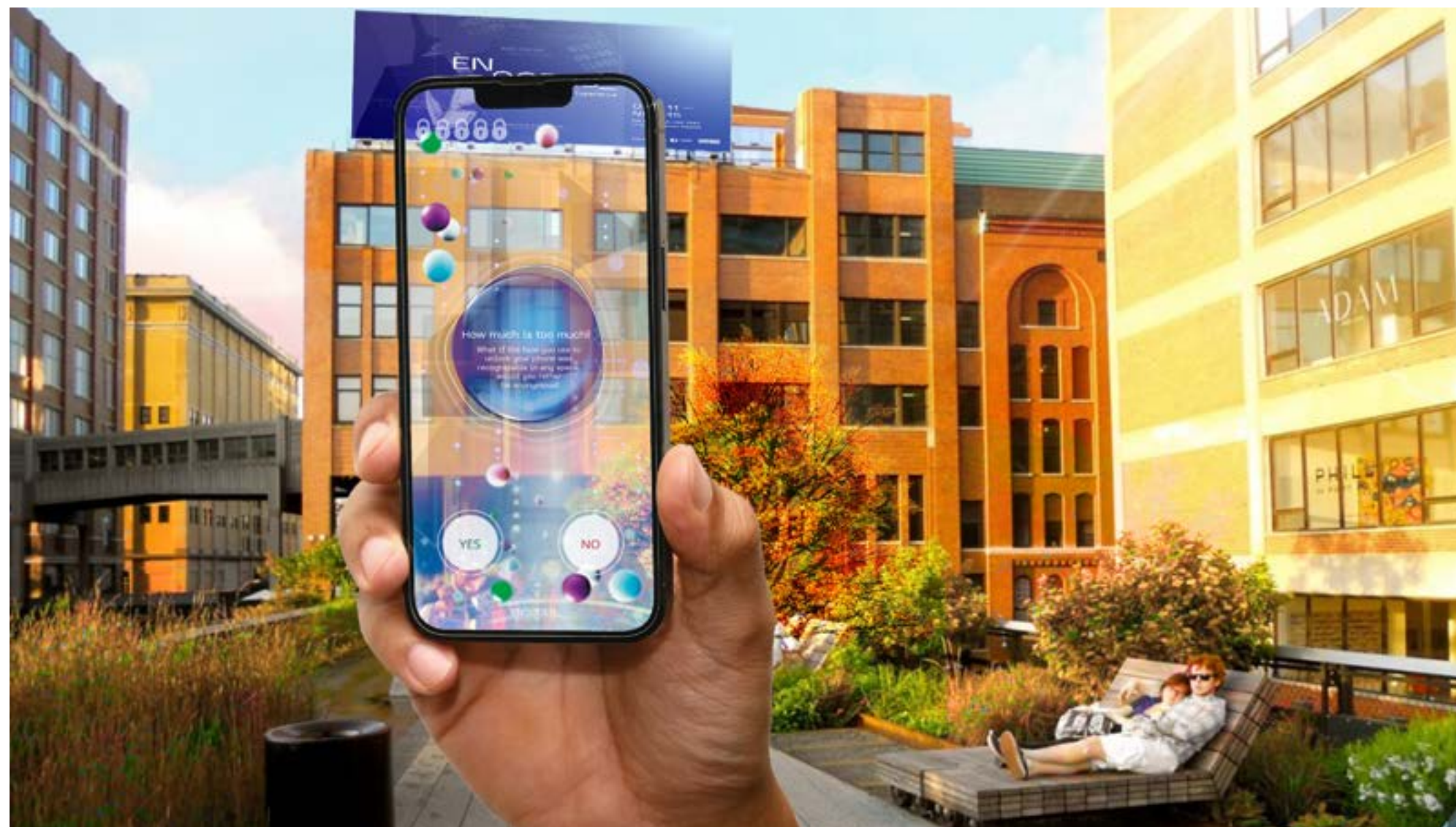

## THE HALO EFFECT

In partnership with EPIC, here they are able to see the live overlays of the simultaneous digital Metaverse event and participating Black Market Flea visitor avatars. A gamified "tracker web" scavenger hunt will appear virtually revealing who's been lurking in their digital shadows alongside short questions related to their digital footprint and technological use. The objective is to collect five locks hidden throughout the experience, which will appear based on their selections, illuminating the values they would like amplified for consumer privacy reform.

# LYKA WILLIAMS

Exhibition & Experience Design

## FASHION INSTITUTE OF TECHNOLOGY

School of Graduate Studies  
272 West 27th St  
New York, NY 10011

### PROJECT

**ENCODED\_**  
The Backend Data Experience

### CLIENT

**BLACK MARKET  
FLEA**

### PARTNERSHIP + SUPPORT



### DISCLAIMER

These drawings are not for construction. This is an unpublished and proprietary work protected under copyright, trade secret, and like laws of the United States and other countries. All rights reserved.

These materials may not be reproduced, displayed, distributed, nor may be the information therein be used or disclosed in whole or in part, without the express written permission of Marlyka Williams.

### KEY PLAN

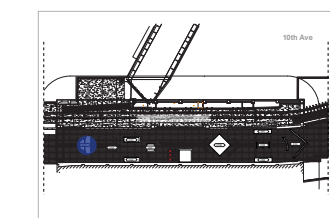

**DRAWN BY** MARLYKA WILLIAMS

**SCALE** NTS

**DATE** December 09, 2022

### DRAWING NAME

C01 Visitor Entry Render

**EX.01.23**



## WORTH THE HYPE

As visitors approach Chelsea Passage, they arrive at a vintage denim customization booth. Payment, however, is strictly data. In order to customize their product, the stunt requires visitors to complete an affiliated data questionnaire requiring selections to be made through providing similar personal information given throughout many online data-driven touchpoints (ie. name, email, phone number). Additional, unorthodox questions are incorporated to generate contemplation (ie. pet's name, the last website browsed, the last item purchased, etc.). All information shared; however, is at the discretion of teach visitor.

# LYKA WILLIAMS

Exhibition & Experience Design

## FASHION INSTITUTE OF TECHNOLOGY

School of Graduate Studies  
272 West 27th St  
New York, NY 10011

### PROJECT

**ENCODED\_**  
The Backend Data Experience

### CLIENT

**BLACK MARKET  
FLEA**

### PARTNERSHIP + SUPPORT



### DISCLAIMER

These drawings are not for construction. This is an unpublished and proprietary work protected under copyright, trade secret, and like laws of the United States and other countries. All rights reserved.

These materials may not be reproduced, displayed, distributed, nor may be the information therein be used or disclosed in whole or in part, without the express written permission of Marlyka Williams.

### KEY PLAN

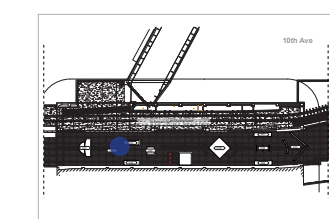

**DRAWN BY** MARLYKA WILLIAMS

**SCALE** NTS

**DATE** December 09, 2022

### DRAWING NAME

C03 Exterior Render

# EX.01.24



## FOR US BY US

Nearby, visitors who “Opted-In” can book one of the two, themed, phygital fitting rooms, where they can pair with a personal stylist from the event who pre-selects digital clothing options based on the data captured from their engagement throughout the experience. Within, visitors can virtually try-on and view the garments in real-time through the interactive mirrored and screened rooms.

# LYKA WILLIAMS

Exhibition & Experience Design

## FASHION INSTITUTE OF TECHNOLOGY

School of Graduate Studies  
272 West 27th St  
New York, NY 10011

### PROJECT

## ENCODED\_

The Backend Data Experience

### CLIENT

## BLACK MARKET FLEA

### PARTNERSHIP + SUPPORT



### DISCLAIMER

These drawings are not for construction. This is an unpublished and proprietary work protected under copyright, trade secret, and like laws of the United States and other countries. All rights reserved.

These materials may not be reproduced, displayed, distributed, nor may be the information therein be used or disclosed in whole or in part, without the express written permission of Marlyka Williams.

### KEY PLAN

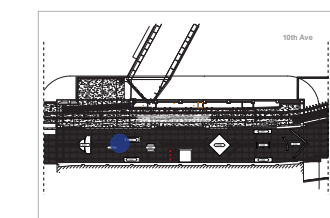

DRAWN BY MARLYKA WILLIAMS

SCALE NTS

DATE December 09, 2022

### DRAWING NAME

C03 Activity Render

# EX.01.25



## FOR US BY US

Visitors who "Opted-out" can also participate in the virtual try-on sessions through their personal smart mobile devices alongside adjacent exhibition mirrors to capture and share the AI-enabled digital garment filters. To encourage engagement, the exhibition incorporates a rewards system to unlock custom content, such as exclusive digital outfits from the featured fashion brands for their virtual avatars. Additional co-creation integrations of real-time user ratings also better enhance these recommendations.

# LYKA WILLIAMS

Exhibition & Experience Design

## FASHION INSTITUTE OF TECHNOLOGY

School of Graduate Studies  
272 West 27th St  
New York, NY 10011

### PROJECT

**ENCODED\_**  
The Backend Data Experience

### CLIENT

**BLACK MARKET  
FLEA**

### PARTNERSHIP + SUPPORT



### DISCLAIMER

These drawings are not for construction. This is an unpublished and proprietary work protected under copyright, trade secret, and like laws of the United States and other countries. All rights reserved.

These materials may not be reproduced, displayed, distributed, nor may be the information therein be used or disclosed in whole or in part, without the express written permission of Marlyka Williams.

### KEY PLAN

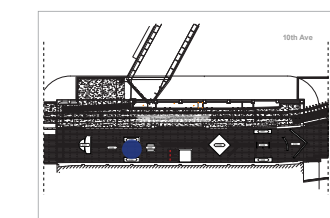

**DRAWN BY** MARLYKA WILLIAMS

**SCALE** NTS

**DATE** December 09, 2022

**DRAWING NAME**

C03 Exterior Render

# EX.01.26



## FOR US BY US

Reinforcing the element of privacy and the lack thereof within the corporatization of the Internet, Two-way mirrors are layered in allowing passerbys to view a few of these visitor interactions.

# LYKA WILLIAMS

Exhibition & Experience Design

## FASHION INSTITUTE OF TECHNOLOGY

School of Graduate Studies  
272 West 27th St  
New York, NY 10011

### PROJECT

**ENCODED\_**  
The Backend Data Experience

### CLIENT

**BLACK MARKET  
FLEA**

### PARTNERSHIP + SUPPORT



### DISCLAIMER

These drawings are not for construction. This is an unpublished and proprietary work protected under copyright, trade secret, and like laws of the United States and other countries. All rights reserved.

These materials may not be reproduced, displayed, distributed, nor may be the information therein be used or disclosed in whole or in part, without the express written permission of Marlyka Williams.

### KEY PLAN

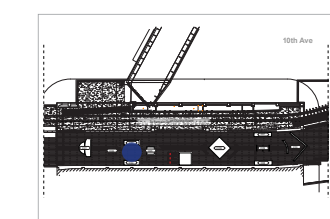

**DRAWN BY** MARLYKA WILLIAMS

**SCALE** NTS

**DATE** December 09, 2022

### DRAWING NAME

C06 Exterior Render

# EX.01.27



## UNAPOLOGETIC

To conclude the experience, visitors arrive at an immersive “data day” visualization. Visitors can approach the available kiosks to provide a biometric face scan or complete a digital multiple choice questionnaire to quantify their typical daily digital interactions. For those who “Opt-out” of providing the biometric face scan, their questionnaire will pair to one of the pre-programmed data profiles.



# LYKA WILLIAMS

Exhibition & Experience Design

## FASHION INSTITUTE OF TECHNOLOGY

School of Graduate Studies  
272 West 27th St  
New York, NY 10011

### PROJECT

## ENCODED\_

The Backend Data Experience

### CLIENT

## BLACK MARKET FLEA

### PARTNERSHIP + SUPPORT



### DISCLAIMER

These drawings are not for construction. This is an unpublished and proprietary work protected under copyright, trade secret, and like laws of the United States and other countries. All rights reserved.

These materials may not be reproduced, displayed, distributed, nor may be the information therein be used or disclosed in whole or in part, without the express written permission of Marlyka Williams.

### KEY PLAN

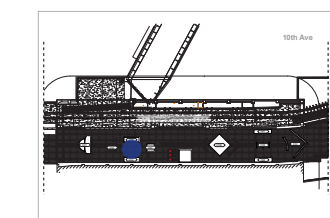

DRAWN BY MARLYKA WILLIAMS

SCALE NTS

DATE December 09, 2022

### DRAWING NAME

C06 Interior Render

# EX.01.28



## UNAPOLOGETIC

For visitors, who “Opt-In”, the experience will activate by sharing an artistic, visual interpretation of their face scan along the screened interfaces in relation to the metaverse digital world. This visual, then, transforms into insights of backend third party trackers affiliated with the touchpoints emphasized throughout their daily routine. Through kinetic interactions, visitors can simply speak a few words or move their bodies to see how these interactions change when in close location to others. This interactive experience is also scaled online for wider reach, connecting to visitors from anywhere in the world.



SCHEDULES + LISTS

# GRAPHIC SCHEDULE

INTRODUCTION	GR. TYPE	DESCRIPTION
A01.GR01	H	Introduction Content Panel
C10.GR01	H	Introduction Content Panel
A05.GR02	E	Introduction Title Panel
A05.GR03	E	Introduction Title Panel
C01.GR04	H	Introduction Title Panel

## WAYFINDING

A00.GR01	F	Exterior Directional Floor Graphic
A00.GR02	F	Exterior Directional Floor Graphic
A00.GR03	F	Exterior Directional Floor Graphic
A00.GR04	F	Exterior Directional Floor Graphic
A00.GR05	F	Exhibition Directional Floor Graphic
A00.GR06	F	Exhibition Directional Floor Graphic
A00.GR07	F	Exhibition Directional Floor Graphic
A00.GR08	F	Exhibition Directional Floor Graphic
A00.GR09	F	Exhibition Directional Floor Graphic
A00.GR10	F	Exhibition Directional Floor Graphic
A00.GR11	I	Freestanding Directional Wayfinding
A00.GR12	I	Freestanding Directional Wayfinding
A00.GR13	I	Freestanding Directional Wayfinding
A00.GR14	I	Freestanding Directional Wayfinding

## EXHIBIT CONTENT

A06.GR15	B	Big Tech Perspective Content Pane
A06.GR16	C	Consumer Perspective Content Pane
A02.GR17	B	Exhibit Zone/Area Content Pane
A02.GR18	B	Exhibit Zone/Area Content Pane
B01.GRA19	B	Exhibit Zone/Area Content Pane
B01.GR20	B	Exhibit Zone/Area Content Pane
B01.GR21	B	Exhibit Zone/Area Content Pane
C02.GR22	E	Exhibit Zone/Area Content Wall

EXHIBIT CONTENT	GR. TYPE	DESCRIPTION
C05.GR23	E	Exhibit Zone/Area Content Wall
C09.GR24	B	Big Tech Perspective Content Pane
C09.GR25	C	Consumer Perspective Content Pane

## LABELS

A03.GR26	D	Exhibit Display Label
A03.GR27	D	Exhibit Display Label
A03.GR28	D	Exhibit Display Label
A03.GR29	D	Exhibit Display Label
A03.GR30	D	Exhibit Display Label
A03.GR31	D	Exhibit Display Label
A04.GR32	D	Exhibit Display Label
A04.GR33	D	Exhibit Display Label
A04.GR34	D	Exhibit Display Label
A04.GR35	D	Exhibit Display Label
A04.GR36	D	Exhibit Display Label
A04.GR37	D	Exhibit Display Label
A05.GR38	D	Exhibit Display Label
A05.GR39	D	Exhibit Display Label
A05.GR40	D	Exhibit Display Label
A05.GR41	D	Exhibit Display Label
A05.GR42	D	Exhibit Display Label
A05.GR43	D	Exhibit Display Label
A05.GR44	D	Exhibit Display Label
A05.GR45	D	Exhibit Display Label
A05.GR46	D	Exhibit Display Label
A05.GR47	D	Exhibit Display Label
A05.GR48	D	Exhibit Display Label
A05.GR49	D	Exhibit Display Label
A05.GR50	D	Exhibit Display Label
A05.GR51	D	Exhibit Display Label

## PROJECT

**ENCODED\_**  
The Backend Data Experience

## CLIENT

**BLACK MARKET  
FLEA**

## PARTNERSHIP + SUPPORT



## DISCLAIMER

These drawings are not for construction. This is an unpublished and proprietary work protected under copyright, trade secret, and like laws of the United States and other countries. All rights reserved.

These materials may not be reproduced, displayed, distributed, nor may be the information therein be used or disclosed in whole or in part, without the express written permission of Marlyka Williams.

## KEY PLAN

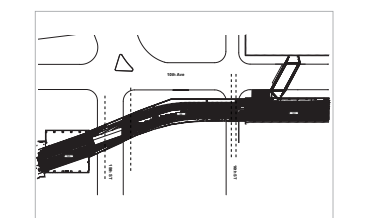

**DRAWN BY** MARLYKA WILLIAMS

**SCALE** NTS

**DATE** December 09, 2022

## DRAWING NAME

Graphic Schedule I

**EX.02.01**

# GRAPHIC SCHEDULE

LABELS	GR. TYPE	DESCRIPTION
A05.GR52	D	Exhibit Display Label
A05.GR53	D	Exhibit Display Label
A05.GR54	D	Exhibit Display Label
A05.GR55	D	Exhibit Display Label
A06.GR56	D	Exhibit Display Label
C07.GR57	D	Exhibit Display Label
C07.GR58	D	Exhibit Display Label
C07.GR59	D	Exhibit Display Label
C07.GR60	D	Exhibit Display Label
C07.GR61	D	Exhibit Display Label
C07.GR62	D	Exhibit Display Label
C08.GR63	D	Exhibit Display Label
C08.GR64	D	Exhibit Display Label
C08.GR65	D	Exhibit Display Label
C08.GR66	D	Exhibit Display Label
C08.GR67	D	Exhibit Display Label
C08.GR68	D	Exhibit Display Label
C09.GR69	D	Exhibit Display Label

## MURALS

C02.GR70	E	Mural Wall Display
C05.GR71	E	Mural Wall Display
C06.GR72	E	Mural Wall Display
C06.GR73	E	Mural Wall Display

## DIGITAL MEDIA

B02.GR74	J	XR Digital Game Display
B02.GR75	J	XR Digital Game Display
C02.GR76	J	Smart Mirror Digital Display
C05.GR77	J	Smart Mirror Digital Display
C06.GR78	J	Kiosk Digital Display

DIGITAL MEDIA	GR. TYPE	DESCRIPTION
C06.GR77	J	Kiosk Digital Display
C06.GR78	J	Kiosk Digital Display
C06.GR79	J	Kiosk Digital Display
C06.GR80	J	Digital Display

## PROJECT

**ENCODED\_**  
The Backend Data Experience

## CLIENT

**BLACK MARKET  
FLEA**

## PARTNERSHIP + SUPPORT



## DISCLAIMER

These drawings are not for construction. This is an unpublished and proprietary work protected under copyright, trade secret, and like laws of the United States and other countries. All rights reserved.

These materials may not be reproduced, displayed, distributed, nor may be the information therein be used or disclosed in whole or in part, without the express written permission of Marlyka Williams.

## KEY PLAN

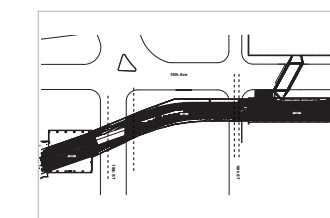

**DRAWN BY** MARLYKA WILLIAMS

**SCALE** NTS

**DATE** December 09, 2022

**DRAWING NAME**

Graphic Schedule II

**EX.02.02**



**DISCLAIMER**

These drawings are not for construction. This is an unpublished and proprietary work protected under copyright, trade secret, and like laws of the United States and other countries. All rights reserved.

These materials may not be reproduced, displayed, distributed, nor may be the information therein be used or disclosed in whole or in part, without the express written permission of Marlyka Williams.

**KEY PLAN**

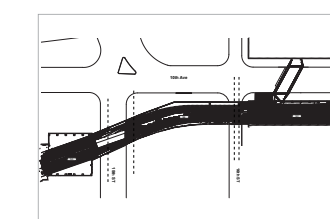

**DRAWN BY** MARLYKA WILLIAMS

**SCALE** NTS

**DATE** December 09, 2022

**DRAWING NAME**







Graphic Specifications

**EX.02.03**

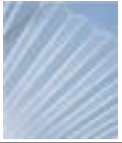
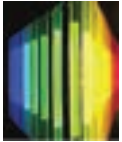
## GRAPHIC SPECIFICATIONS

TYPE	DESCRIPTION
A	1/8" colored Blue 5B021 GT ACRYLITE® Premium Panels, encased within reflective chrome metal frame, blind fasteners, direct print, first surface type, second surface color and graphic, UV overlam
B	1/8" colored Blue 5B021 GT ACRYLITE® Premium Panels, encased within reflective chrome metal frame, blind fasteners, direct print surface type and/or graphic, UV overlam
C	1/8" colored Ruby 3B020GT ACRYLITE® Premium Panels, encased within reflective chrome metal frame, blind fasteners, direct print surface type and/or graphic, UV overlam
D	1/8" colorless ACRYLITE® Satinice Panels, encased within reflective chrome metal frame, blind fasteners, direct print surface type and/or graphic, UV overlam
E	Direct Print on Vinyl, 2" boarder, direct to surface application
F	Surface adhered Vinyl floor graphic
G	1" Embossed Acrylic Type, Surface adhered to FABBACK® First Surface (2-Sided) Mirror Acrylic sheet
H	Disublimation on mesh stretched fabric, silicone lined wrapped return, UV overlam
I	1/4" acrylic dimensional letter mounted to 3/4" lazer cut acrylic circles, steel calble strung through acrylic circlces with set screws
J	Digital Display

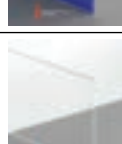
# FINISH SCHEDULE

MATERIAL	CODE	LOCATION	DESCRIPTION	IMAGE
Acrylic	ACRL001	A01, C11 C02, C03, C04, C05	1/8" smooth surfaced corrugated acrylic- ACRYLITE® Resist wave profile White Smooth W1621, 72% Translucency	
	ACRL002	A01, C11 C02, C03, C04, C05	ACRYLITE® LED Light Guiding Edge Lit Rod, OEO11 XL	
	ACRL003	A00, A06, C10 C07, C08, C09	1/8" ACRYLITE® Premium FF Ruby Edge 3B020 GT	
	ACRL004	A00, A06, C10 A02 A03, A04, A05	1/8" ACRYLITE® Premium FF Blue 5b021 GT	
	ACRL005	A06, C10	1/8" ACRYLITE® Satinice optimum light diffusion Colorless 0D010 DF	
Mirror Acrylic	MCRL001	A03, A04, A05 C07, C08, C09 B02 C02, C03, C04, C05	1/8" ACRYLITE® Reflections mirror Colorless 0A000 X2	
	MCRL002	A03, A04, A05 C07, C08, C09 B02 C02, C03, C04, C05	1/8" ACRYLITE® Reflections mirror Blue 5C028 X2	
	MCRL003	A06, C10 A02 A03, A04, A05 C07, C08, C09	1/16" ACRYLITE® Gallery non-glare P99 Colorless 0A000 AR	
	MCRL004	C02, C03, C04, C05	1/8" FABBAC® First Surface (2-Sided) Mirror Acrylic	
Aluminum	ALU001	A00, A03, A04, A05 C07, C08, C09 B01 C06	Custom Molded Aluminum metal rods, reflective chrome finish	

## LYKA WILLIAMS

Exhibition & Experience Design

### FASHION INSTITUTE OF TECHNOLOGY

School of Graduate Studies  
272 West 27th St  
New York, NY 10011

#### PROJECT

**ENCODED\_**  
The Backend Data Experience

#### CLIENT

**BLACK MARKET  
FLEA**

#### PARTNERSHIP + SUPPORT



#### DISCLAIMER

These drawings are not for construction. This is an unpublished and proprietary work protected under copyright, trade secret, and like laws of the United States and other countries. All rights reserved.

These materials may not be reproduced, displayed, distributed, nor may be the information therein be used or disclosed in whole or in part, without the express written permission of Marlyka Williams.

#### KEY PLAN

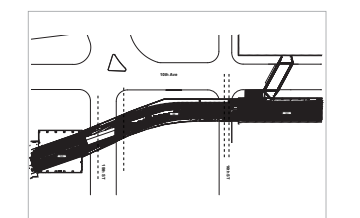

**DRAWN BY** MARLYKA WILLIAMS

**SCALE** NTS

**DATE** December 09, 2022

**DRAWING NAME**

Finish Schedule I

**EX.02.04**

# FINISH SCHEDULE

MATERIAL	CODE	LOCATION	DESCRIPTION	IMAGE
Aluminum	ALU002	A03, A04, A05 C07, C08, C09	Metal Base with blind fasteners, reflective chrome finish	
	ALU003	A01, C11 C02, C03, C04, C05	Corrugated Aluminum, reflective chrome finish	
	ALU004	A03, A04, A05 C07, C08, C09 C06	Embossed Water Ripple metal cladding	
Fabric Mesh	FABMSH001	A02	PVC Fabric Mesh Slatts Ceiling Mounted	
	FABMSH02	C01	Stretch fabric mesh with silicone wrapped return	
Wood	WD001	A03, A04, A05 C07, C08, C09 C02, C03, C04, C05 C06	Vertical Wall Substrate, Painted Finish	
Paint	PNTE001	C01 C02, C03, C04, C05	Color Match Pantone 2597 C, satin finish	
	PNTE002	A03, A04, A05 C07, C08, C09	Color Match Pantone 72C, satin finish	
VINYL	VYNL001	C01 C02, C03, C04, C05	Silver Opaque Metal Mirror Decorative Film	
	VYNL002	C02, C03, C04, C05	Flexible Mirror Chrome film adhesive vinyl	

**PROJECT**



**CLIENT**



**PARTNERSHIP + SUPPORT**



**DISCLAIMER**

These drawings are not for construction. This is an unpublished and proprietary work protected under copyright, trade secret, and like laws of the United States and other countries. All rights reserved.

These materials may not be reproduced, displayed, distributed, nor may be the information therein be used or disclosed in whole or in part, without the express written permission of Marlyka Williams.

**KEY PLAN**

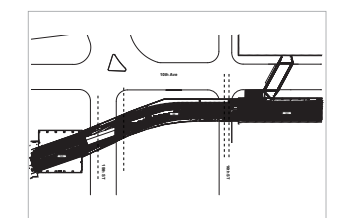

**DRAWN BY** MARLYKA WILLIAMS

**SCALE** NTS

**DATE** December 09, 2022





**DRAWING NAME**

Finish Schedule II

**EX.02.05**

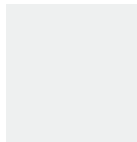

# LIGHTING + MEDIA SCHEDULE

CODE	TYPE	MANUFACTURER	DESCRIPTION	LOCATION	IMAGE
L01	LED	Luminii	Line LED WD68 (340 lm/ft) Warm Dim LED Strip: 19k-27k, 19k-24k, or like small profile, high output	A03, A04, A04 C07, C08, C09 B02 C02, C03, C04, C05	
L02	LED	Luminii	Backlight Illumination Matrix Plus High Efficiency Grid LED panel - 24 VDC	A01, C10	
L03	LED	Luminii	Recessed LED Spotlight, Micro Optic Narrow Flood	A01, C10 C06	
L04	LED	Color Kinetics	RGBW LED Ground Spotlight ColorBurst 6 10° Clear Lens, Black Housing, 25w	C01 C02, C03, C04, C05 C06	

CODE	TYPE	MANUFACTURER	DESCRIPTION	LOCATION	IMAGE
AV1	Projector	Benq	LK936ST 4K Resolution Short-Throw Blue Core Laser Projector	A02	
AV2	Interactive Digital Kiosk	Fabricator to Advise	Exhibition Kiosk	C06	
AV3	LED Interactive Digital Screen	Electrosonic	1/8" FABBAC® First Surface (2-Sided) Mirror Acrylic	C06	
AV4	AR Smart Mirror	Metro Click	2' x 8' full-HD multi-touch display digital mirror with touch and motion tracking technology	C06	

**PROJECT**

**ENCODED\_**  
The Backend Data Experience

**CLIENT**

**BLACK MARKET  
FLEA**

**PARTNERSHIP + SUPPORT**



**DISCLAIMER**

These drawings are not for construction. This is an unpublished and proprietary work protected under copyright, trade secret, and like laws of the United States and other countries. All rights reserved.

These materials may not be reproduced, displayed, distributed, nor may be the information therein be used or disclosed in whole or in part, without the express written permission of Marlyka Williams.

**KEY PLAN**

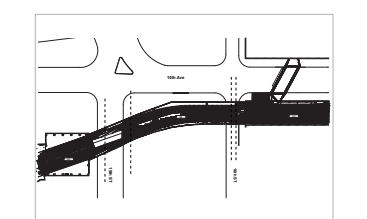

**DRAWN BY** MARLYKA WILLIAMS

**SCALE** NTS











**DATE** December 09, 2022

**DRAWING NAME**

Lighting + Media Schedule

**EX.02.06**

# OBJECT + ARTIFACT SCHEDULE

CODE	DESCRIPTION	MEDIUM	IMAGE
A03.FAS. AR001	Black Market Flea Vendor / Retailer Plaid puffer denim ensemble	Fashion	
A04.FAS. AR002	Black Market Flea Vendor / Retailer Lavender cropped jacket set	Fashion	
A05.FAS. AR003	Black Market Flea Vendor / Retailer Black and yellow mesh two-piece	Fashion	
A05.FAS. AR004	Black Market Flea Vendor / Retailer Fur green jumpsuit	Fashion	
A05.FAS. AR005	Black Market Flea Vendor / Retailer Long neck clear glass vessel	Ceramics	
A05.FAS. AR006	Black Market Flea Vendor / Retailer Natural and white ceramic swirl vase	Ceramics	
A05.FAS. AR007	Black Market Flea Vendor / Retailer Craft antique gold hammered metal vase	Ceramics	
A05.FAS. AR008	Black Market Flea Vendor / Retailer Tall natural textured sand glaze ceramic vase	Ceramics	
A05.FAS. AR009	Black Market Flea Vendor / Retailer Craft black hand carved wood zephanya vase	Ceramics	
A05.FAS. AR010	Black Market Flea Vendor / Retailer Tall clear glass faceted jug vase	Ceramics	

CODE	DESCRIPTION	MEDIUM	IMAGE
A05.FAS. AR011	Black Market Flea Vendor / Retailer Juniper Clay Black bowl basin, matte finish	Ceramics	
A05.LFS. AR012	Black Market Flea Vendor / Retailer Ceramics Meltdown Ceramic basin with primary colors, Patterned gloss finish	Ceramics	
A05.LFS. AR013	Black Market Flea Vendor / Retailer Camille at the Wheel Stacked ceramic bowls, Embossed crackle finish	Ceramic	
A05.CER. AR014	Black Market Flea Vendor / Retailer Sio Ceramics Cermic bowls of quirky shapes, gloss finish	Ceramics	
A05.CER. AR015	Black Market Flea Vendor / Retailer Tasha Throws Raw Ceramic vases with white embossed pattern, gloss finish	Ceramics	
A05.CER. AR016	Black Market Flea Vendor / Retailer The Coy Collection Coiled vase basin, terracota matter dried finish	Ceramics	
A05.CER. AR017	Black Market Flea Vendor / Retailer Tactile Matter Large bowl basin with pastel decorative accents	Ceramics	
A05.CER. AR018	Black Market Flea Vendor / Retailer Cavo after a good cry candle	Lifestyle	
A05.CER. AR019	Black Market Flea Vendor / Retailer Harlem josephine candle	Lifestyle	
A05.CER. AR020	Black Market Flea Vendor / Retailer Marie burgos calebasse candle	Lifestyle	

**PROJECT**

**ENCODED\_**  
The Backend Data Experience

**CLIENT**

**BLACK MARKET  
FLEA**

**PARTNERSHIP + SUPPORT**



**DISCLAIMER**

These drawings are not for construction. This is an unpublished and proprietary work protected under copyright, trade secret, and like laws of the United States and other countries. All rights reserved.

These materials may not be reproduced, displayed, distributed, nor may be the information therein be used or disclosed in whole or in part, without the express written permission of Marlyka Williams.

**KEY PLAN**

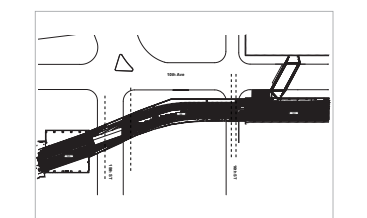

**DRAWN BY** MARLYKA WILLIAMS

**SCALE** NTS







**DATE** December 09, 2022



**DRAWING NAME**

Object + Artifact Schedule I

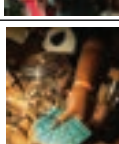
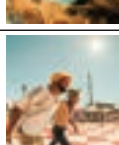
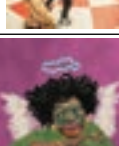
**EX.02.07**

# OBJECT + ARTIFACT SCHEDULE

CODE	DESCRIPTION	MEDIUM	IMAGE
A03.PRT. AR021	Black Market Flea Photographer Zay Monae Tryna Stay Sucka Free in a world full of lollipops	Photography Prints	
A03.PRT. AR022	Black Market Flea Photographer Zay Monae Views from the DJ booth of visitors and guests	Photography Prints	
A03.PRT. AR023	Black Market Flea Photographer Zay Monae Performer and MC by branded banner and Beehive marquee	Photography Prints	
A03.PRT. AR024	Black Market Flea Photographer Zay Monae All that glitters, wall of gold hoops	Photography Prints	
A03.PRT. AR025	Black Market Flea Photographer Zay Monae Energy of the flea, black men dancing rhythmically	Photography Prints	
A03.PRT. AR026	Black Market Flea Photographer Zay Monae Hands holding Black Market Flea Frequency Bucks	Photography Prints	
A03.PRT. AR027	Black Market Flea Photographer Zay Monae Black men exhibiting joy on the roller rink	Photography Prints	
A04.PRT. AR028	Black Market Flea Vendor / Retailer Sinalo Ngcaba Canvas printing of softened/ angelic black woman	Poster Prints	
A04.PRT. AR029	Black Market Flea Vendor / Retailer Sinalo Ngcaba Linoleum block print of black city youth	Poster Prints	
A03.PRT. AR030	Black Market Flea Vendor / Retailer Sinalo Ngcaba Black diaspora male featuring cool hues in contrasting negative space	Poster Prints	

CODE	DESCRIPTION	MEDIUM	IMAGE
A04.PRT. AR031	Black Market Flea Vendor / Retailer Sinalo Ngcaba Collectors Poster BMF 09.24 Poster	Poster Prints	
A04.PRT. AR032	Black Market Flea Vendor / Retailer Sinalo Ngcaba Collectors Poster BMF 10.09 Poster	Poster Prints	
A04.PRT. AR033	Black Market Flea Vendor / Retailer Sinalo Ngcaba Frequency Bucks	Poster Prints	

**PROJECT**

**ENCODED\_**  
The Backend Data Experience

**CLIENT**

**BLACK MARKET  
FLEA**

**PARTNERSHIP + SUPPORT**



**DISCLAIMER**

These drawings are not for construction. This is an unpublished and proprietary work protected under copyright, trade secret, and like laws of the United States and other countries. All rights reserved.

These materials may not be reproduced, displayed, distributed, nor may be the information therein be used or disclosed in whole or in part, without the express written permission of Marlyka Williams.

**KEY PLAN**

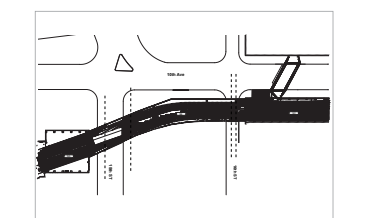

**DRAWN BY** MARLYKA WILLIAMS

**SCALE** NTS

**DATE** December 09, 2022

**DRAWING NAME**

Object + Artifact Schedule II

**EX.02.08**



PLANS, SECTIONS, + ELEVATIONS



These drawings are not for construction. This is an unpublished and proprietary work protected under copyright, trade secret, and like laws of the United States and other countries. All rights reserved.

These materials may not be reproduced, displayed, distributed, nor may be the information therein be used or disclosed in whole or in part, without the express written permission of Marlyka Williams.

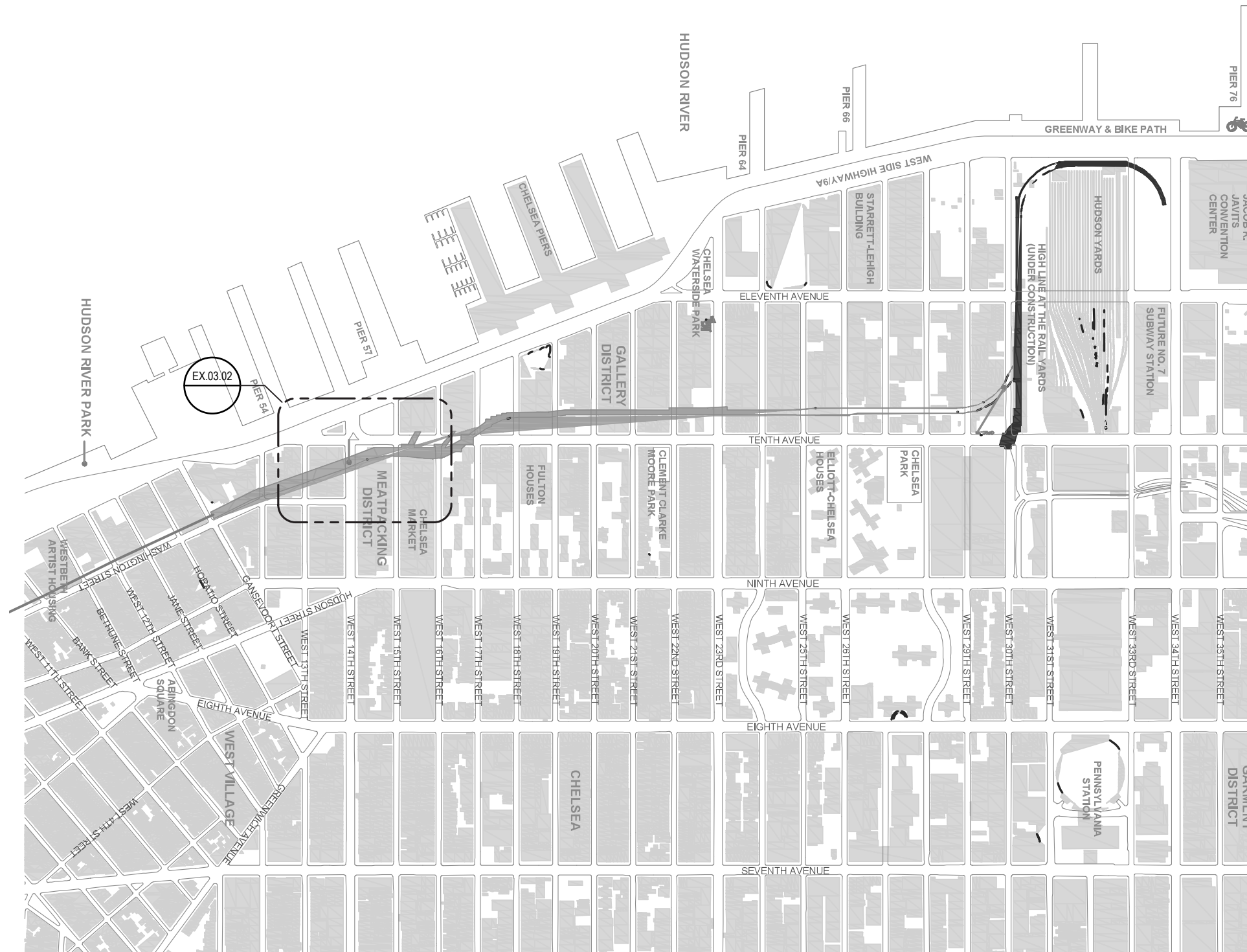
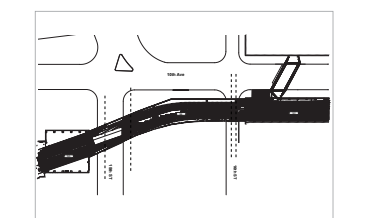

**1 SITE LOCATION PLAN - THE HIGH LINE**  
Scale: NTS



DISCLAIMER

These drawings are not for construction. This is an unpublished and proprietary work protected under copyright, trade secret, and like laws of the United States and other countries. All rights reserved.

These materials may not be reproduced, displayed, distributed, nor may be the information therein be used or disclosed in whole or in part, without the express written permission of Marlyka Williams.

KEY PLAN

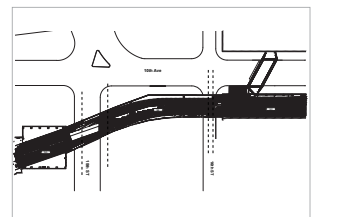

DRAWN BY MARLYKA WILLIAMS

SCALE NTS

DATE December 09, 2022

DRAWING NAME

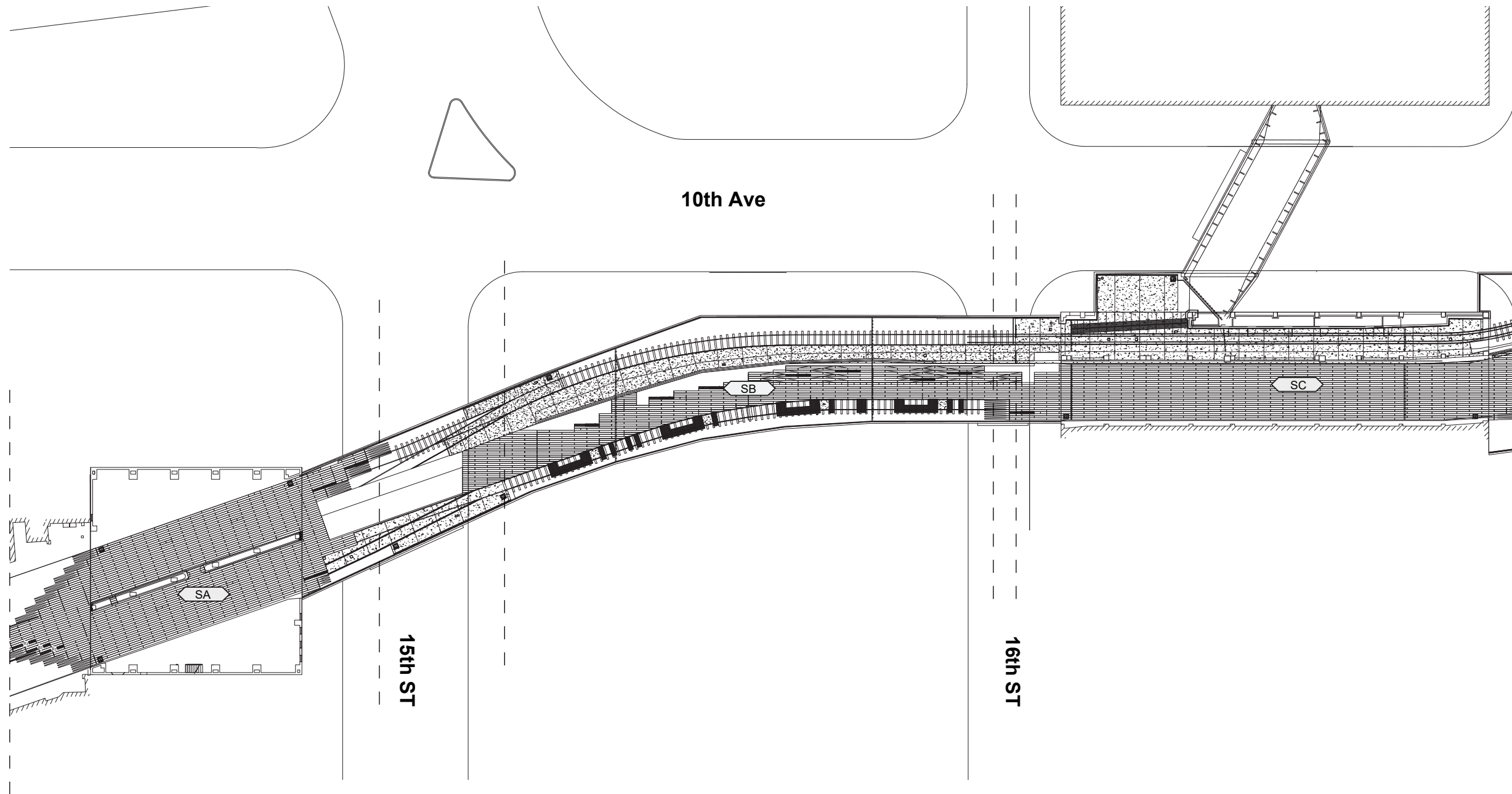

Site Plan

**EX.03.02**



**1 FULL SITE PLAN**  
Scale: NTS

LEGEND:

-  SA 14TH ST PASSAGE
-  SB DILLER VON FURSTENBERG SUNDECK
-  SC CHELSEA MARKET PASSAGE

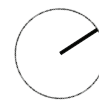



**DISCLAIMER**

These drawings are not for construction. This is an unpublished and proprietary work protected under copyright, trade secret, and like laws of the United States and other countries. All rights reserved.

These materials may not be reproduced, displayed, distributed, nor may be the information therein be used or disclosed in whole or in part, without the express written permission of Marlyka Williams.

**KEY PLAN**

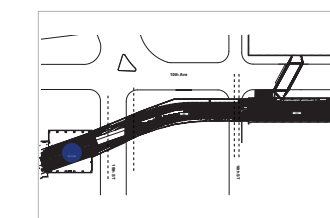

**DRAWN BY** MARLYKA WILLIAMS

**SCALE** 3/32" = 1'-0"

**DATE** December 09, 2022

**DRAWING NAME**

SA Dimensioned Floorplan

**EX.03.03**

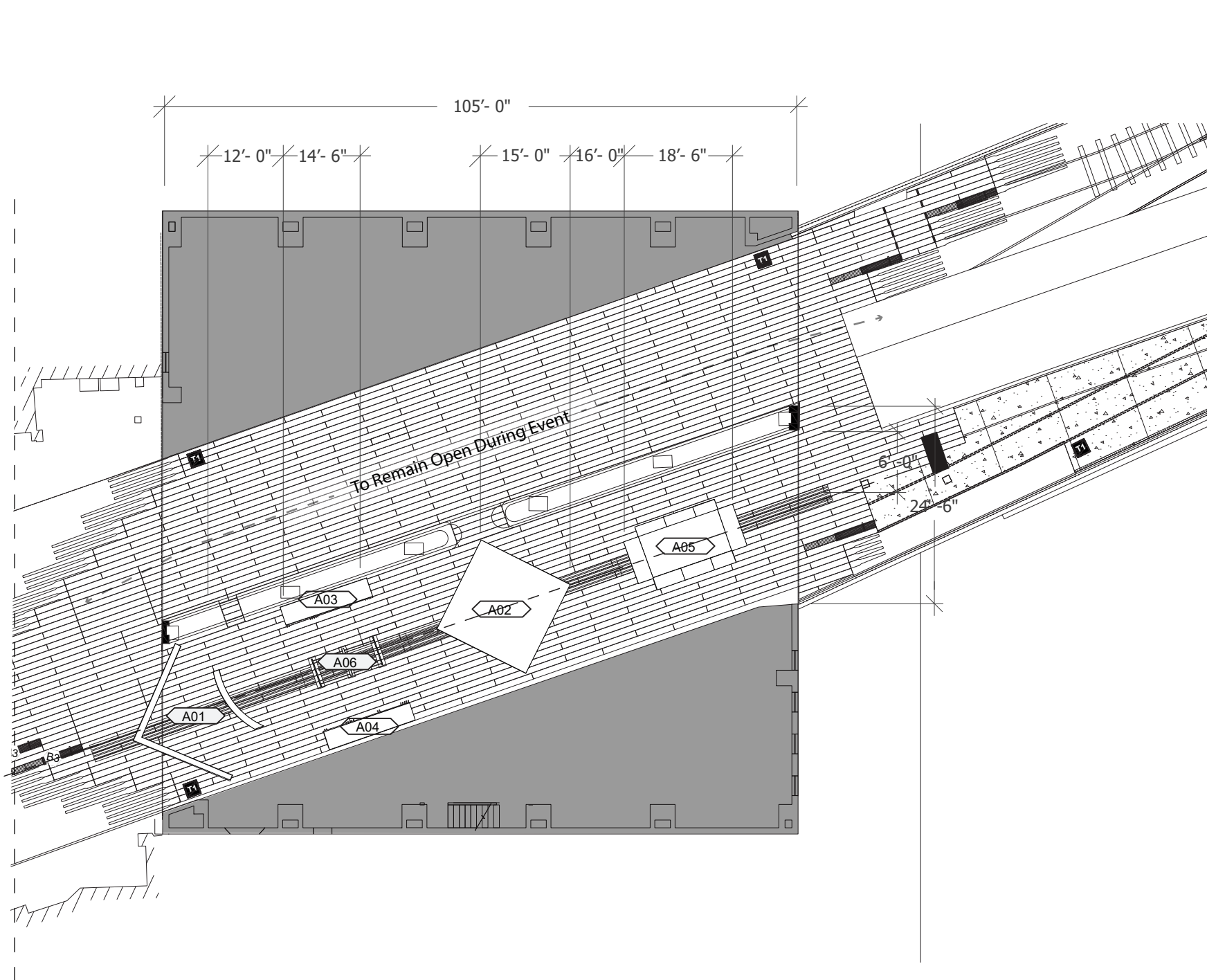

15th St

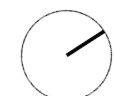

**1 SA DIMENSIONED FLOORPLAN - 14TH STREET PASSAGE**  
Scale: 3/32" = 1'0"





These drawings are not for construction. This is an unpublished and proprietary work protected under copyright, trade secret, and like laws of the United States and other countries. All rights reserved.

These materials may not be reproduced, displayed, distributed, nor may be the information therein be used or disclosed in whole or in part, without the express written permission of Marlyka Williams.

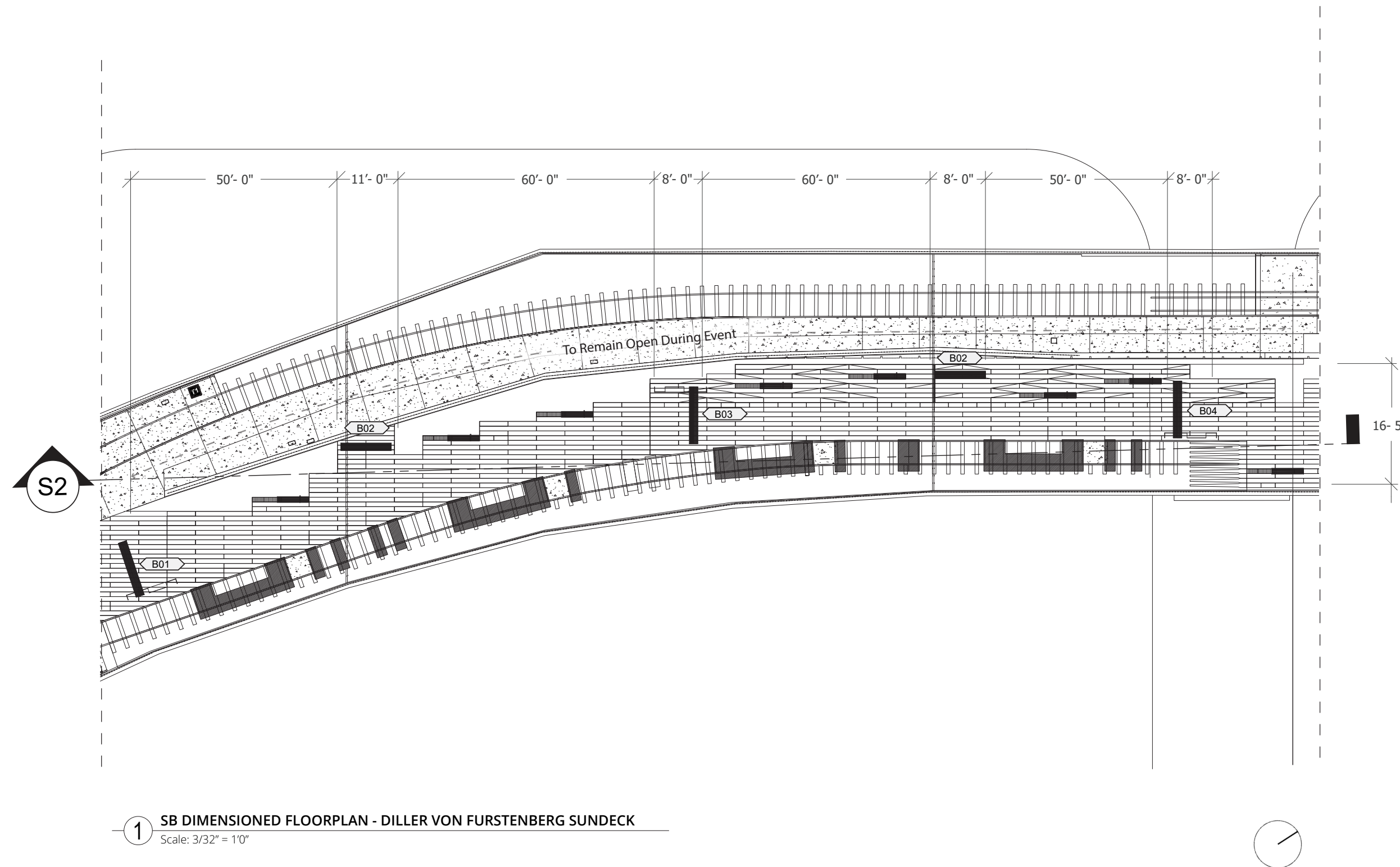
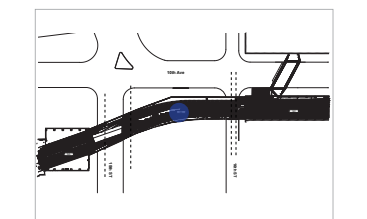

**1 SB DIMENSIONED FLOORPLAN - DILLER VON FURSTENBERG SUNDECK**  
Scale: 3/32" = 1'0"



These drawings are not for construction. This is an unpublished and proprietary work protected under copyright, trade secret, and like laws of the United States and other countries. All rights reserved.

These materials may not be reproduced, displayed, distributed, nor may be the information therein be used or disclosed in whole or in part, without the express written permission of Marlyka Williams.

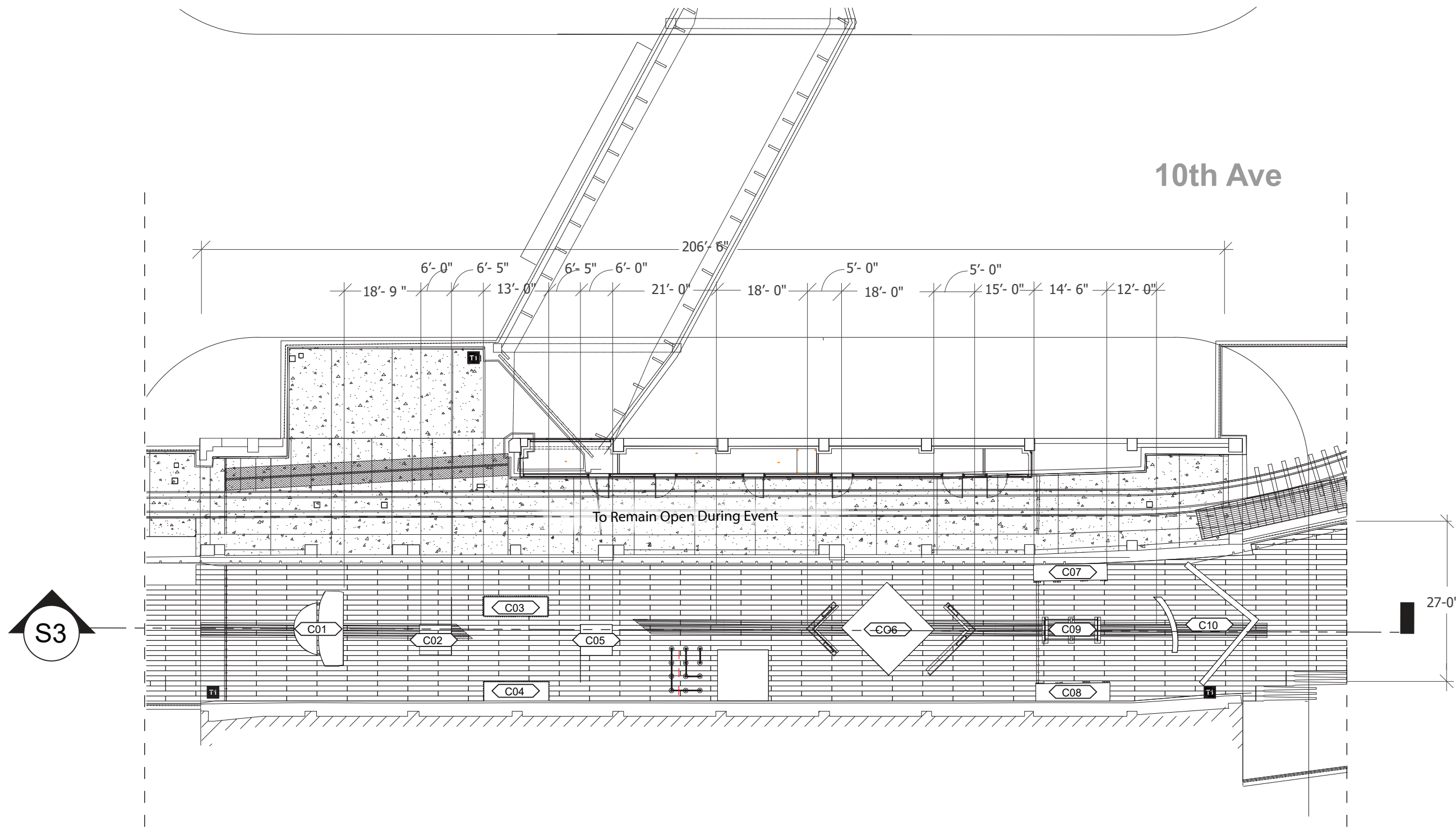
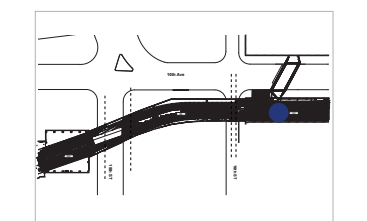

**1 SC DIMENSIONED FLOORPLAN - CHELSEA PASSAGE**  
Scale: 3/32" = 1'-0"





These drawings are not for construction. This is an unpublished and proprietary work protected under copyright, trade secret, and like laws of the United States and other countries. All rights reserved.

These materials may not be reproduced, displayed, distributed, nor may be the information therein be used or disclosed in whole or in part, without the express written permission of Marlyka Williams.

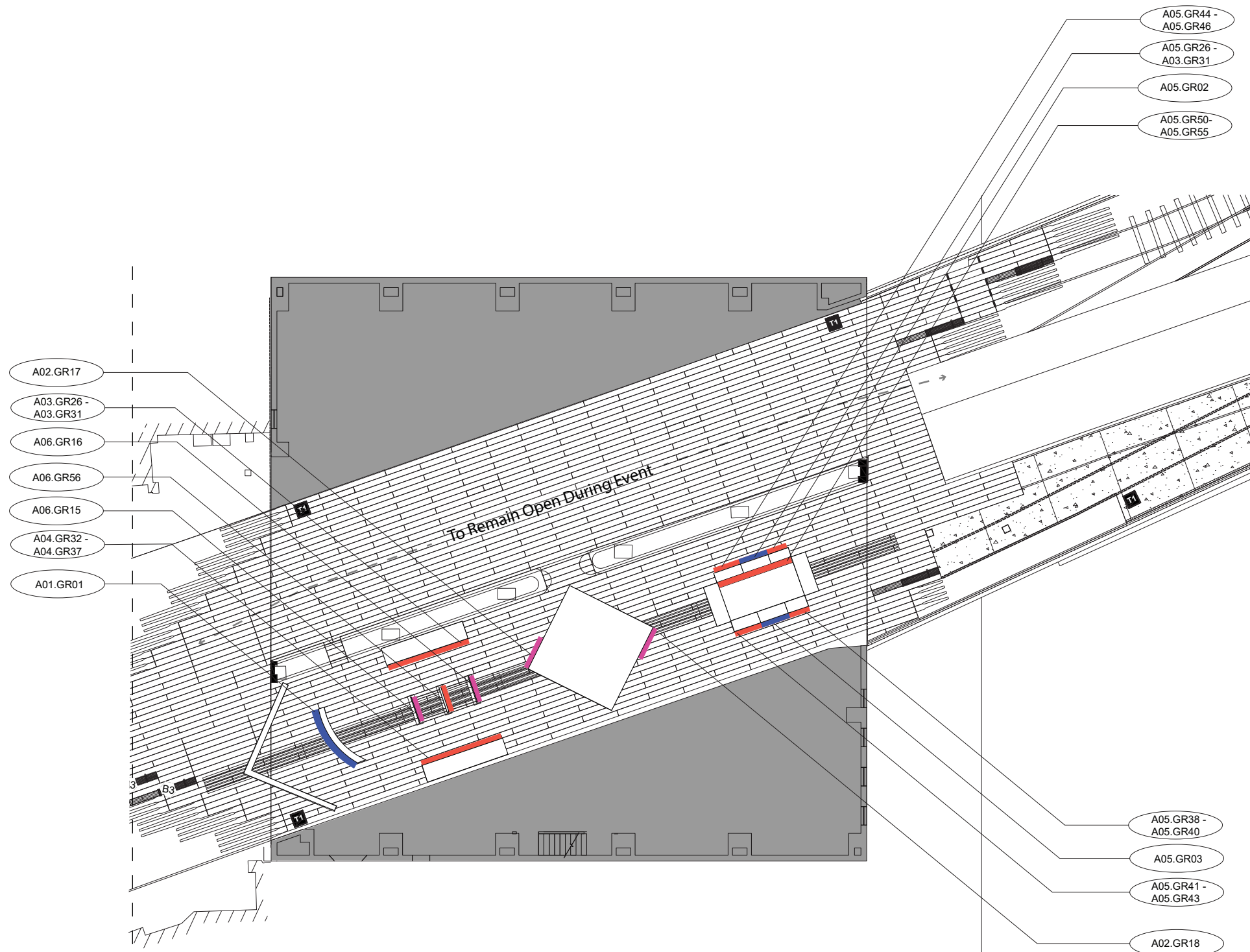
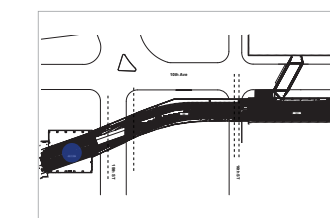

- LEGEND:
- INTRODUCTION
  - EXHIBIT CONTENT
  - LABELS
  - DIGITAL MEDIA
  - WAYFINDING
  - MURALS



**1 SA GRAPHIC LOCATION PLAN - 14TH STREET PASSAGE**  
Scale: 3/32" = 1'0"



These drawings are not for construction. This is an unpublished and proprietary work protected under copyright, trade secret, and like laws of the United States and other countries. All rights reserved.

These materials may not be reproduced, displayed, distributed, nor may be the information therein be used or disclosed in whole or in part, without the express written permission of Marlyka Williams.

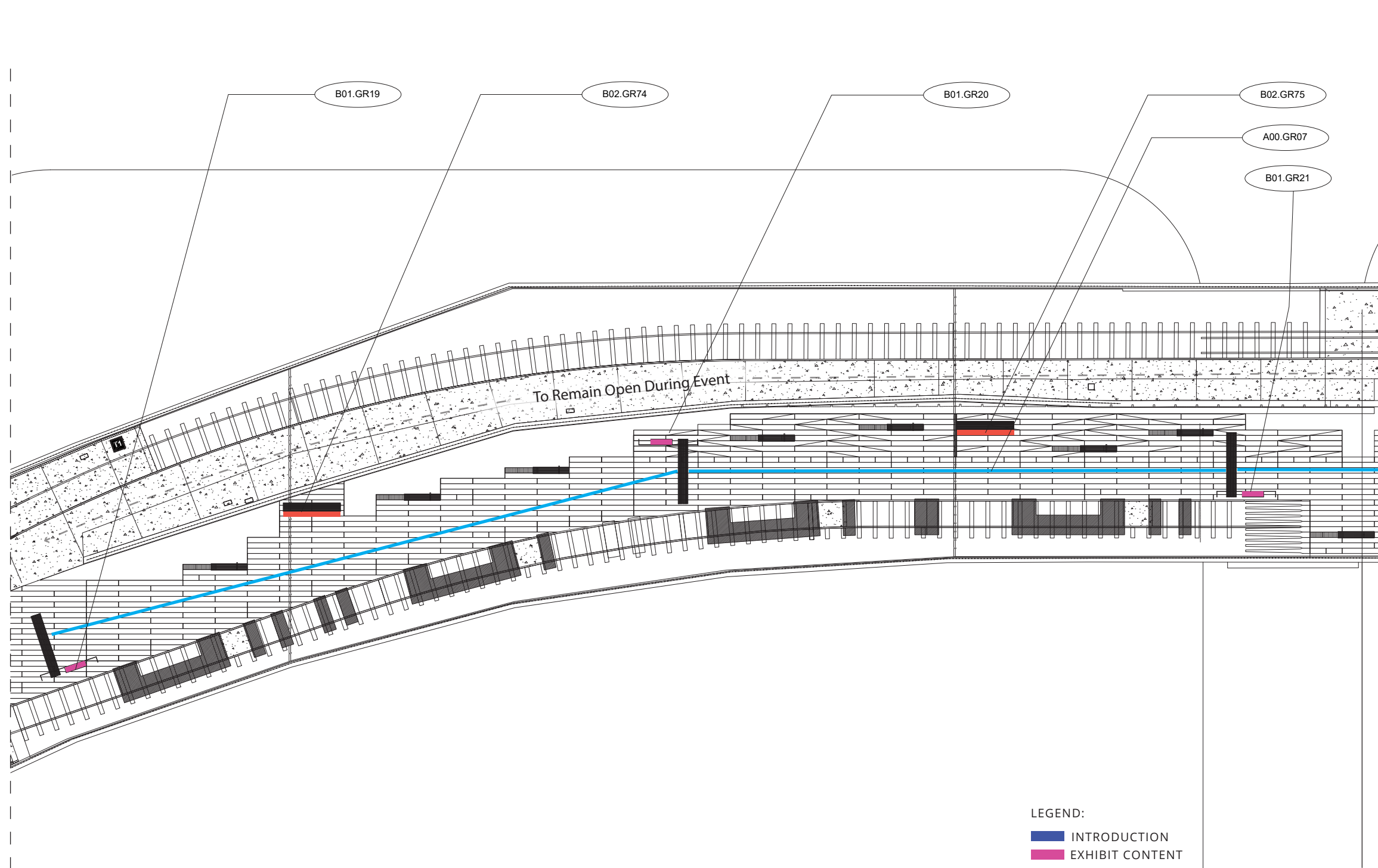
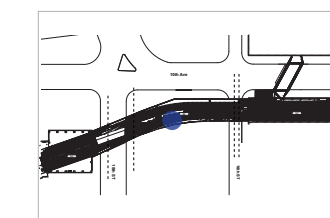

**LEGEND:**

- INTRODUCTION
- EXHIBIT CONTENT
- LABELS
- DIGITAL MEDIA
- WAYFINDING
- MURALS

**1 SB GRAPHIC LOCATION PLAN - DILLER VON FURSTENBERG SUNDECK**  
Scale: 3/32" = 1'0"





These drawings are not for construction. This is an unpublished and proprietary work protected under copyright, trade secret, and like laws of the United States and other countries. All rights reserved.

These materials may not be reproduced, displayed, distributed, nor may be the information therein be used or disclosed in whole or in part, without the express written permission of Marlyka Williams.

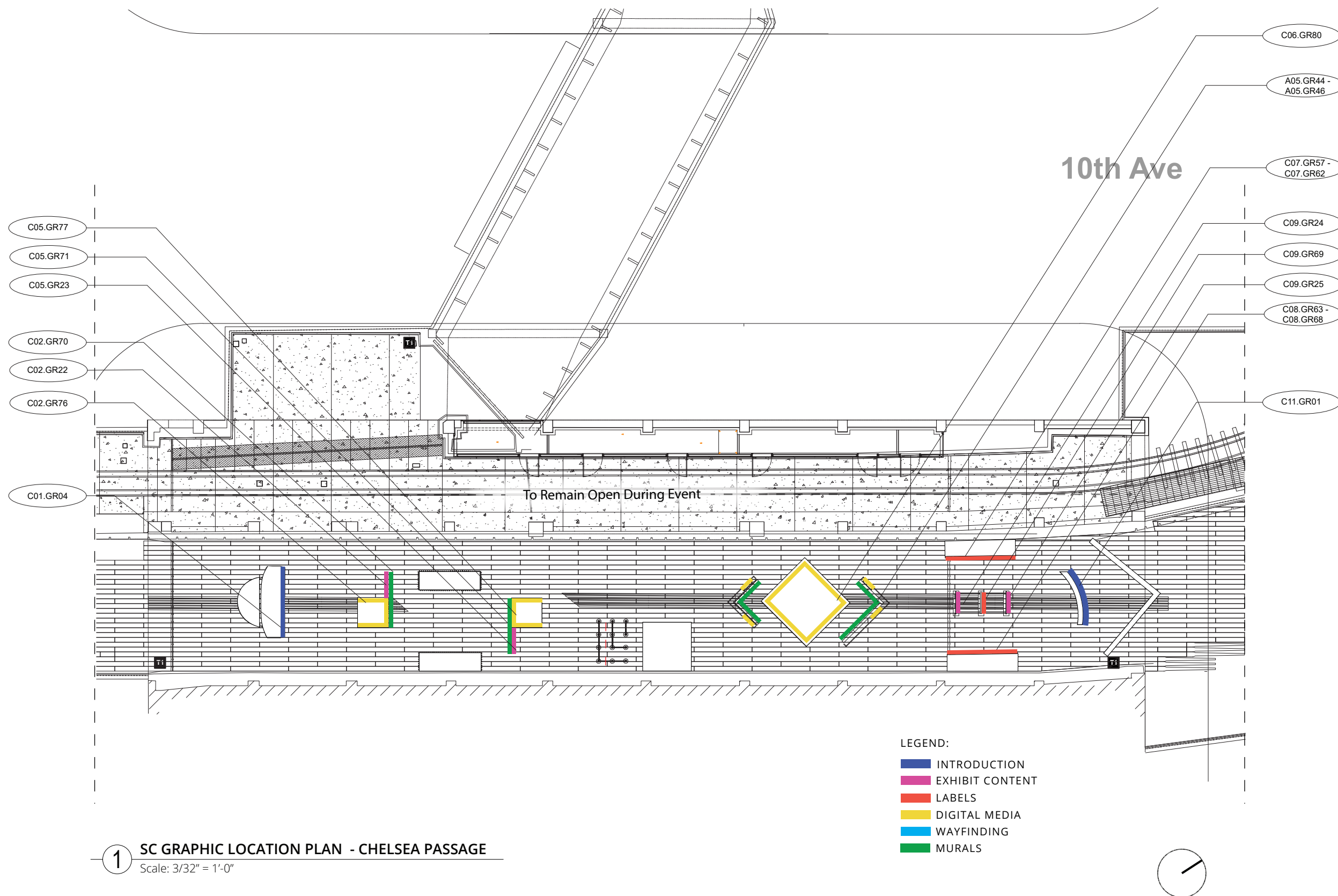
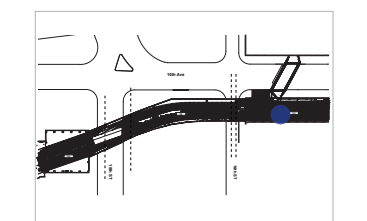

**1 SC GRAPHIC LOCATION PLAN - CHELSEA PASSAGE**  
Scale: 3/32" = 1'-0"

**LYKA WILLIAMS**

Exhibition & Experience Design

**FASHION INSTITUTE OF TECHNOLOGY**

School of Graduate Studies  
272 West 27th St  
New York, NY 10011

**PROJECT**

**ENCODED\_**  
The Backend Data Experience

**CLIENT**

**BLACK MARKET FLEA**

**PARTNERSHIP + SUPPORT**



**DISCLAIMER**

These drawings are not for construction. This is an unpublished and proprietary work protected under copyright, trade secret, and like laws of the United States and other countries. All rights reserved.

These materials may not be reproduced, displayed, distributed, nor may be the information therein be used or disclosed in whole or in part, without the express written permission of Marlyka Williams.

**KEY PLAN**

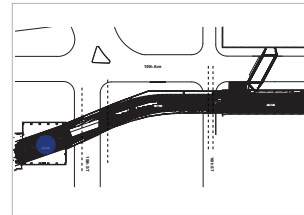

**DRAWN BY** MARLYKA WILLIAMS

**SCALE** 3/32" - 1'-0"

**DATE** December 09, 2022

**DRAWING NAME**

SA Material Plan

**EX.03.09**

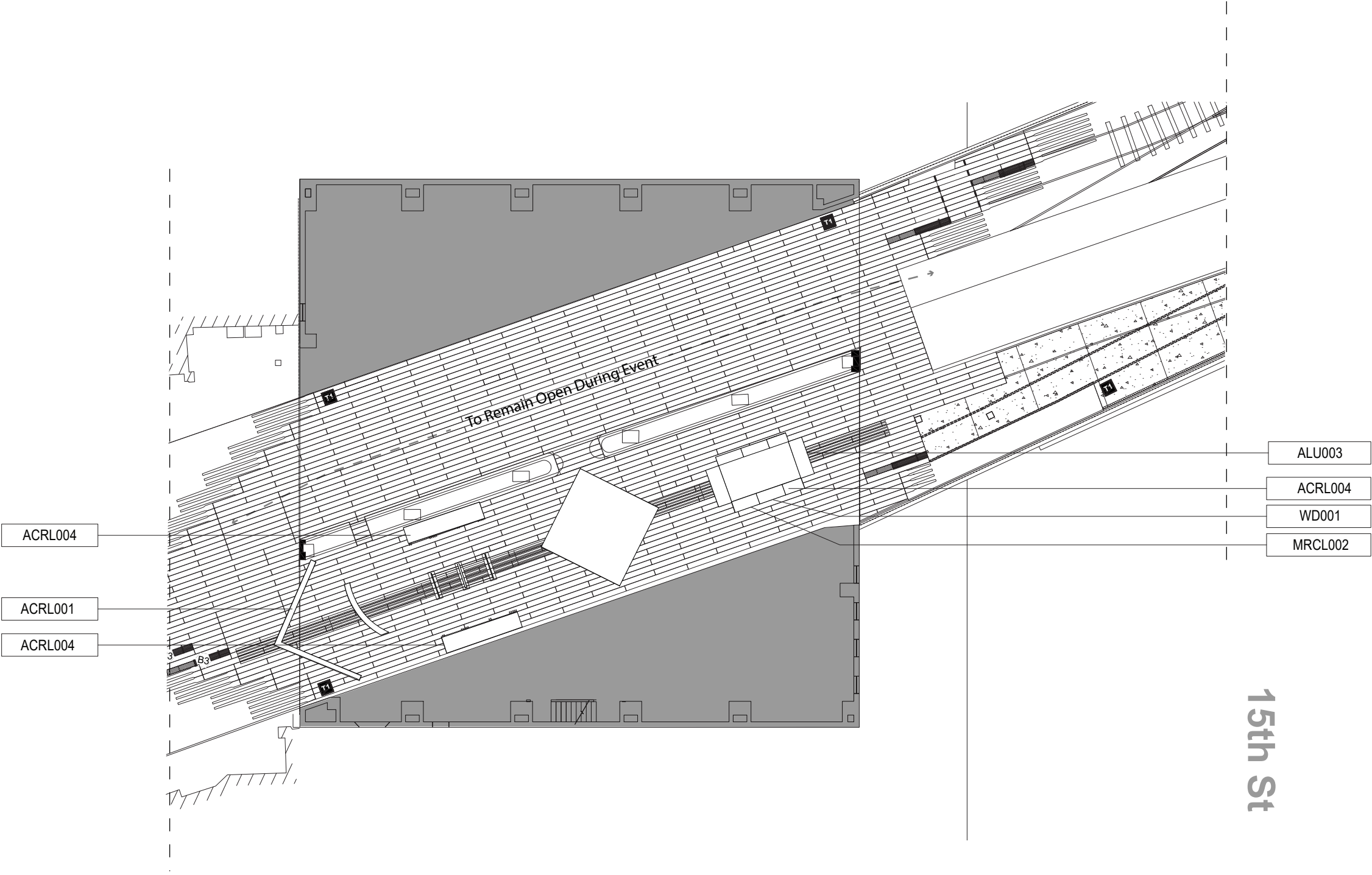

**1 SA MATERIAL PLAN - 14TH STREET PASSAGE**  
Scale: 3/32" = 1'0"



DISCLAIMER

These drawings are not for construction. This is an unpublished and proprietary work protected under copyright, trade secret, and like laws of the United States and other countries. All rights reserved.

These materials may not be reproduced, displayed, distributed, nor may be the information therein be used or disclosed in whole or in part, without the express written permission of Marlyka Williams.

KEY PLAN

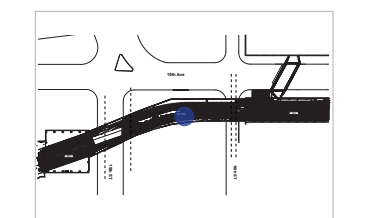

DRAWN BY MARLYKA WILLIAMS

SCALE 3/32" = 1'-0"

DATE December 09, 2022

DRAWING NAME

SB Material Plan

**EX.03.10**

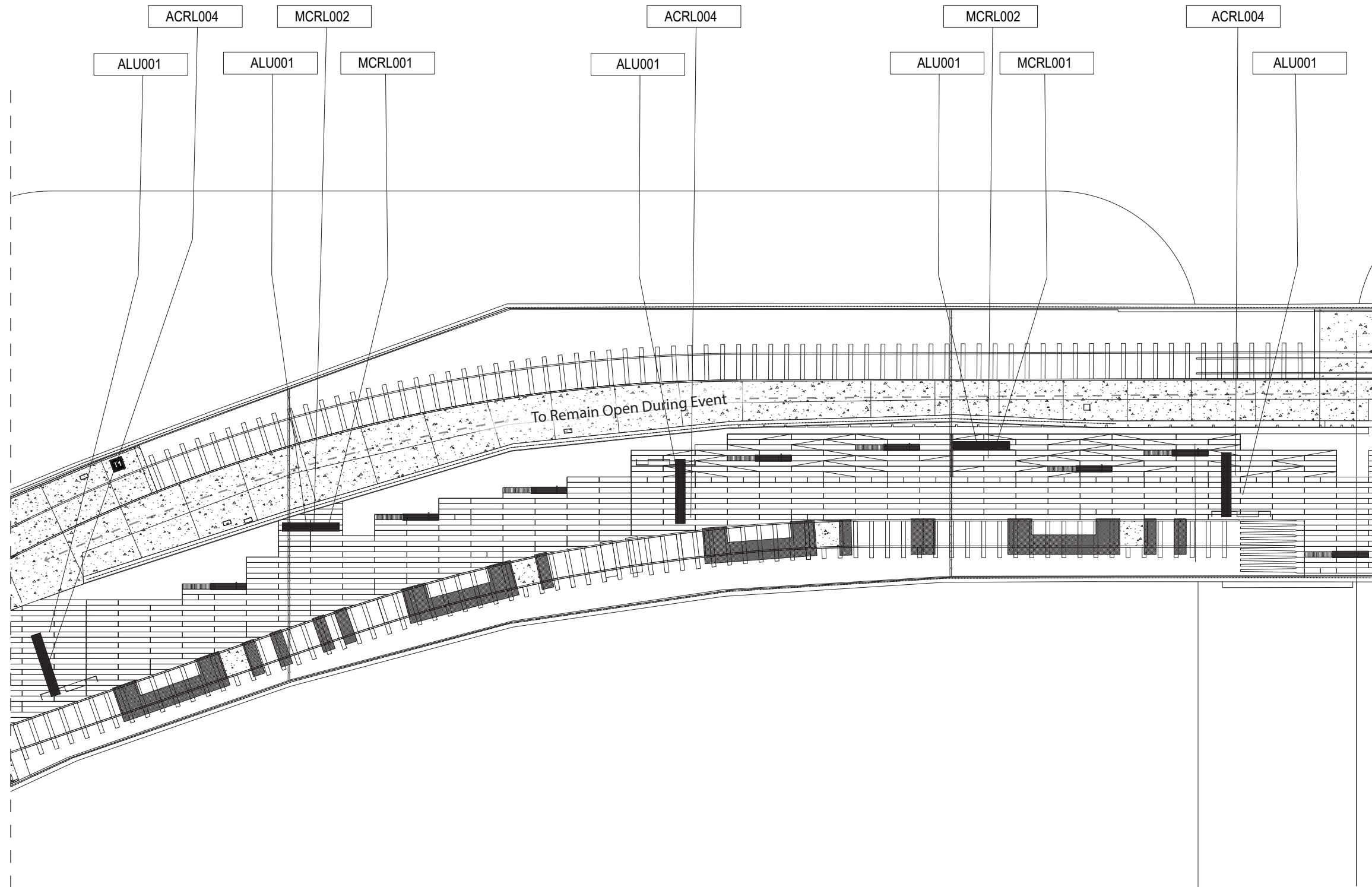

**1 SB MATERIAL PLAN - DILLER VON FURSTENBERG SUNDECK**  
Scale: 3/32" = 1'-0"



**DISCLAIMER**

These drawings are not for construction. This is an unpublished and proprietary work protected under copyright, trade secret, and like laws of the United States and other countries. All rights reserved.

These materials may not be reproduced, displayed, distributed, nor may be the information therein be used or disclosed in whole or in part, without the express written permission of Marlyka Williams.

**KEY PLAN**

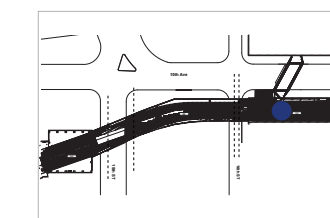

**DRAWN BY** MARLYKA WILLIAMS

**SCALE** 3/32" = 1'-0"

**DATE** December 09, 2022

**DRAWING NAME**

SC Material Plan

**EX.03.11**

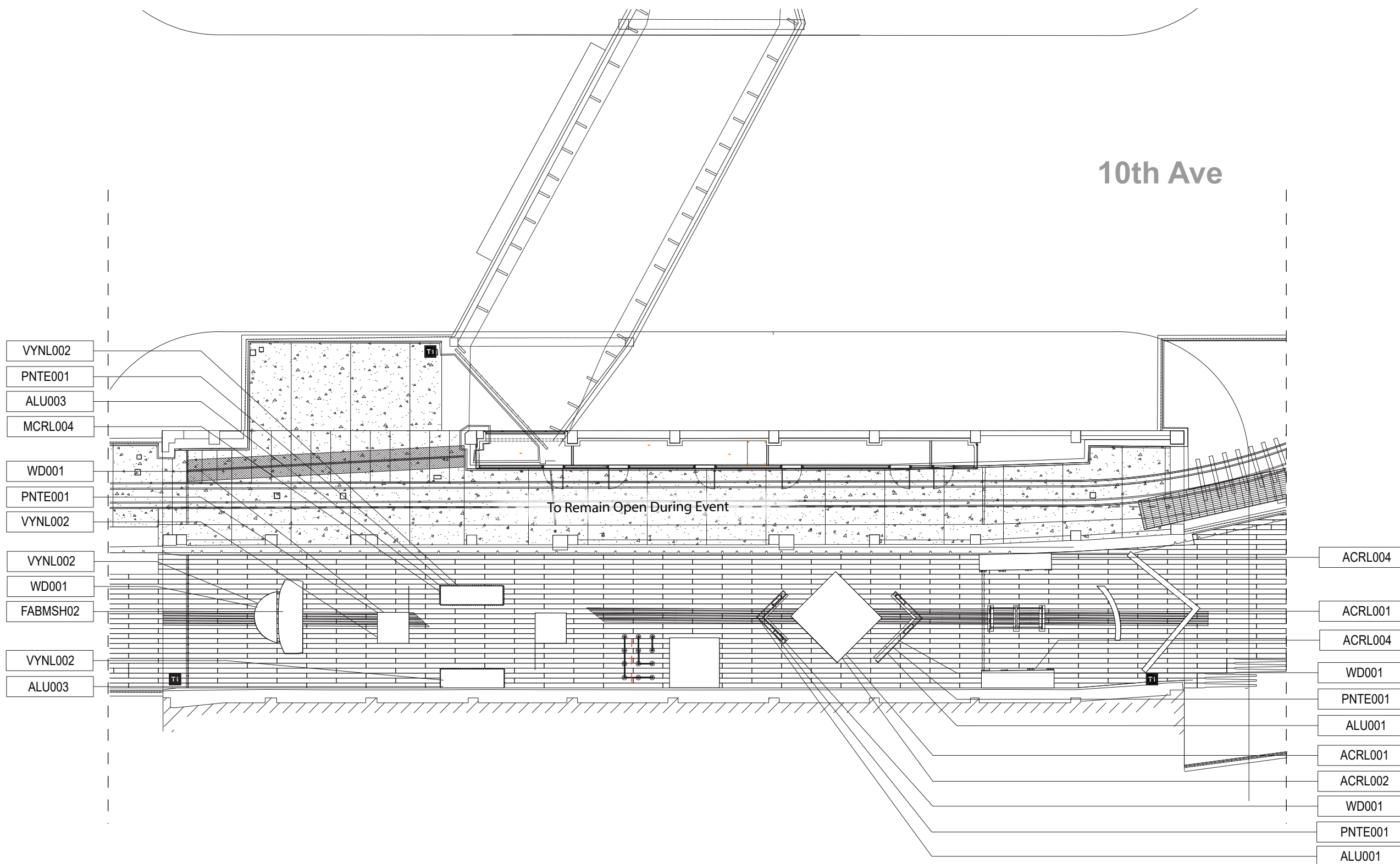

**1 SC MATERIAL PLAN - CHELSEA PASSAGE**  
Scale: 3/32" = 1'-0"



**LYKA WILLIAMS**

Exhibition & Experience Design

**FASHION INSTITUTE OF TECHNOLOGY**

School of Graduate Studies  
272 West 27th St  
New York, NY 10011

**PROJECT**

**ENCODED\_**  
The Backend Data Experience

**CLIENT**

**BLACK MARKET FLEA**

**PARTNERSHIP + SUPPORT**



**DISCLAIMER**

These drawings are not for construction. This is an unpublished and proprietary work protected under copyright, trade secret, and like laws of the United States and other countries. All rights reserved.

These materials may not be reproduced, displayed, distributed, nor may be the information therein be used or disclosed in whole or in part, without the express written permission of Marlyka Williams.

**KEY PLAN**

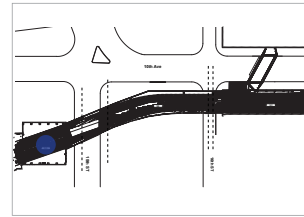

**DRAWN BY** MARLYKA WILLIAMS

**SCALE** 3/32" - 1'-0"

**DATE** December 09, 2022

**DRAWING NAME**

SA Media + Power Plan

**EX.03.12**

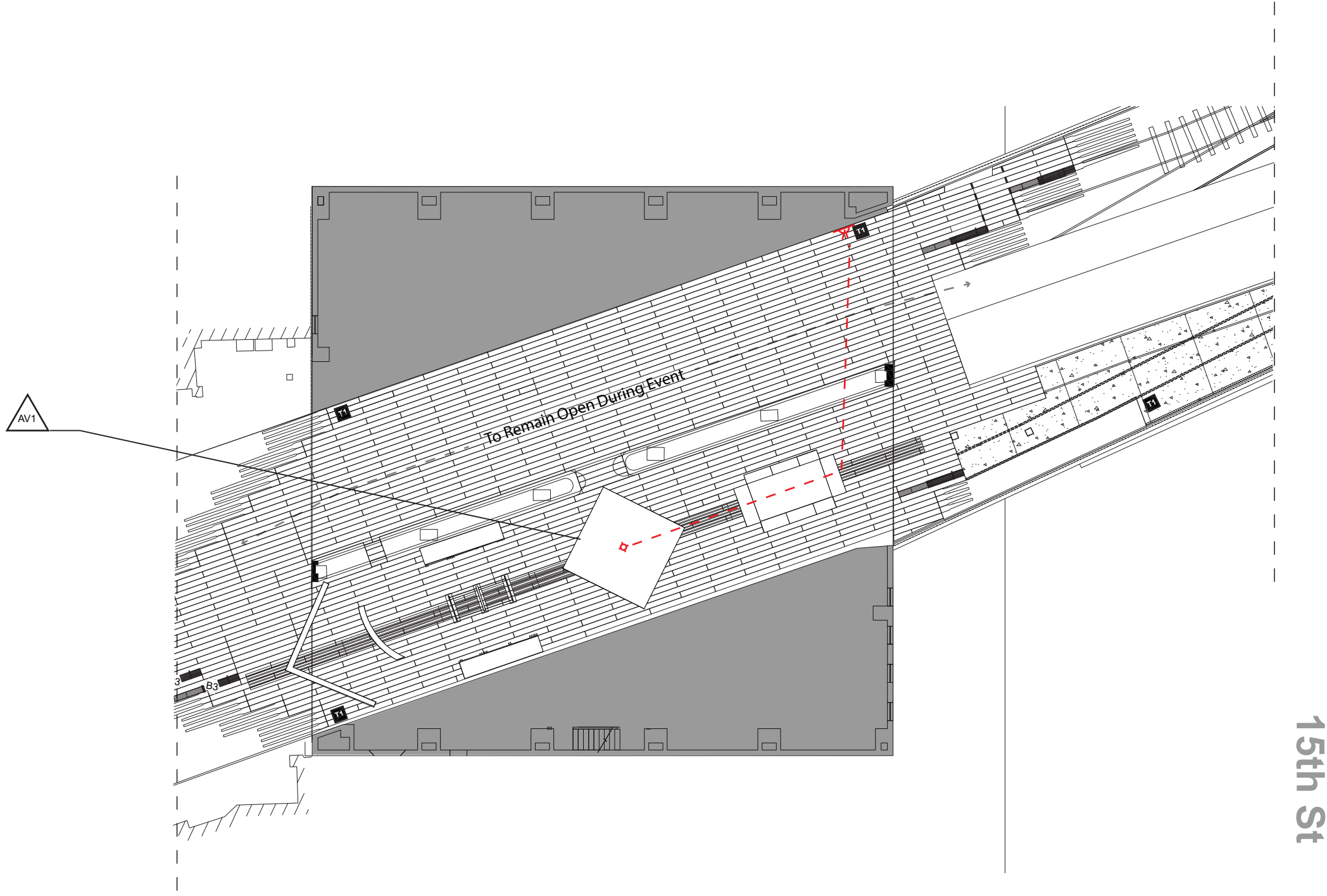

15th St



**1 SA MEDIA + POWER PLAN - 14TH STREET PASSAGE**

Scale: 3/32" = 1'0"



These drawings are not for construction. This is an unpublished and proprietary work protected under copyright, trade secret, and like laws of the United States and other countries. All rights reserved.

These materials may not be reproduced, displayed, distributed, nor may be the information therein be used or disclosed in whole or in part, without the express written permission of Marlyka Williams.

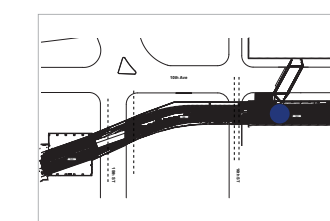

10th Ave

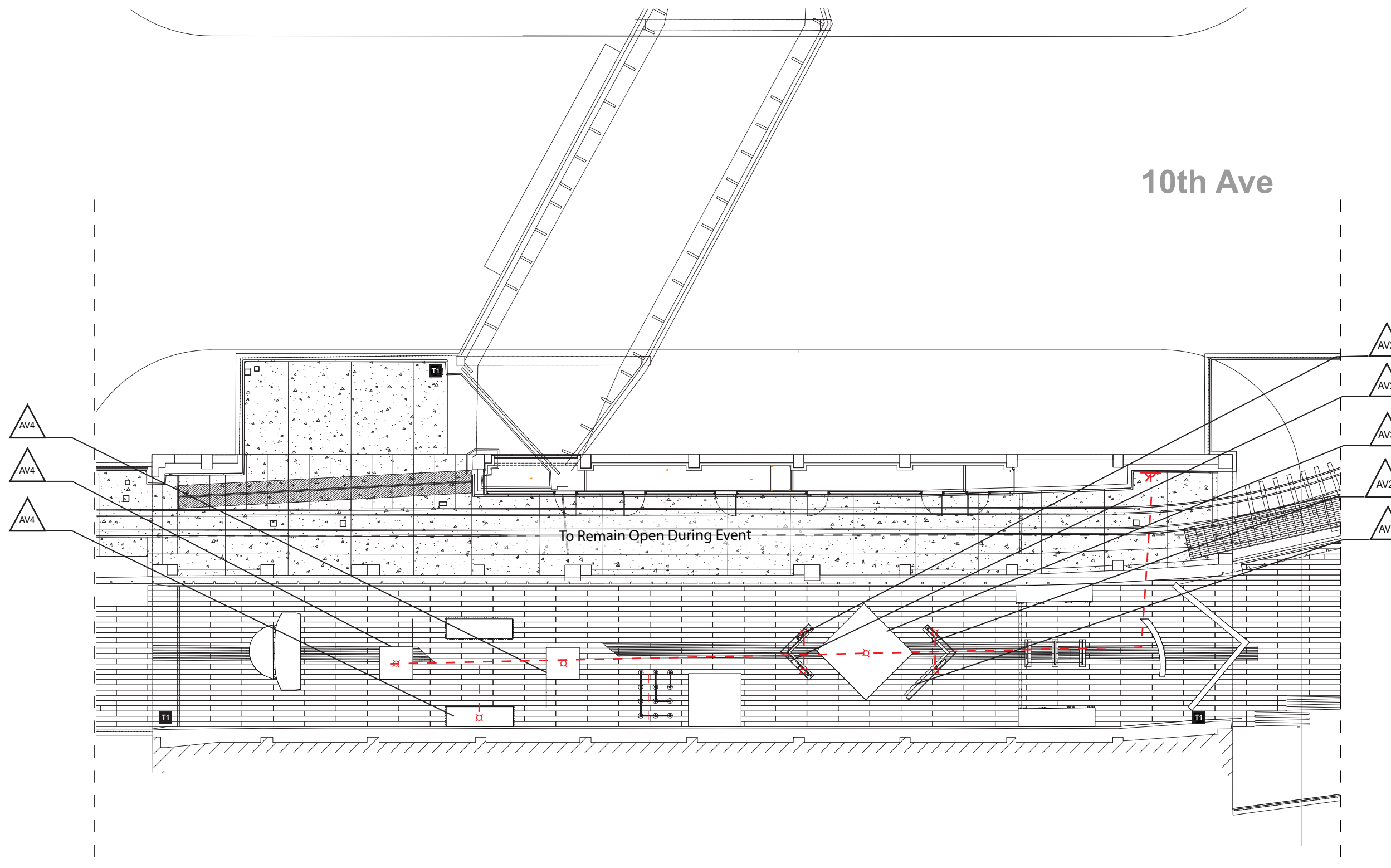

To Remain Open During Event

1 SC MEDIA + POWER PLAN - CHELSEA PASSAGE

Scale: 3/32" = 1'-0"

**PROJECT**

**ENCODED\_**  
The Backend Data Experience

**CLIENT**

**BLACK MARKET FLEA**

**PARTNERSHIP + SUPPORT**



**DISCLAIMER**

These drawings are not for construction. This is an unpublished and proprietary work protected under copyright, trade secret, and like laws of the United States and other countries. All rights reserved.

These materials may not be reproduced, displayed, distributed, nor may be the information therein be used or disclosed in whole or in part, without the express written permission of Marlyka Williams.

**KEY PLAN**

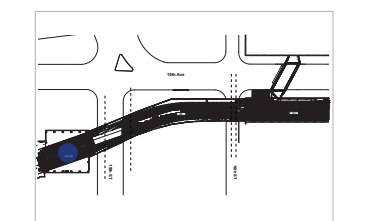

**DRAWN BY** MARLYKA WILLIAMS

**SCALE** 3/32" = 1'-0"

**DATE** December 09, 2022

**DRAWING NAME**

SA object + Artifact Plan

**EX.03.14**

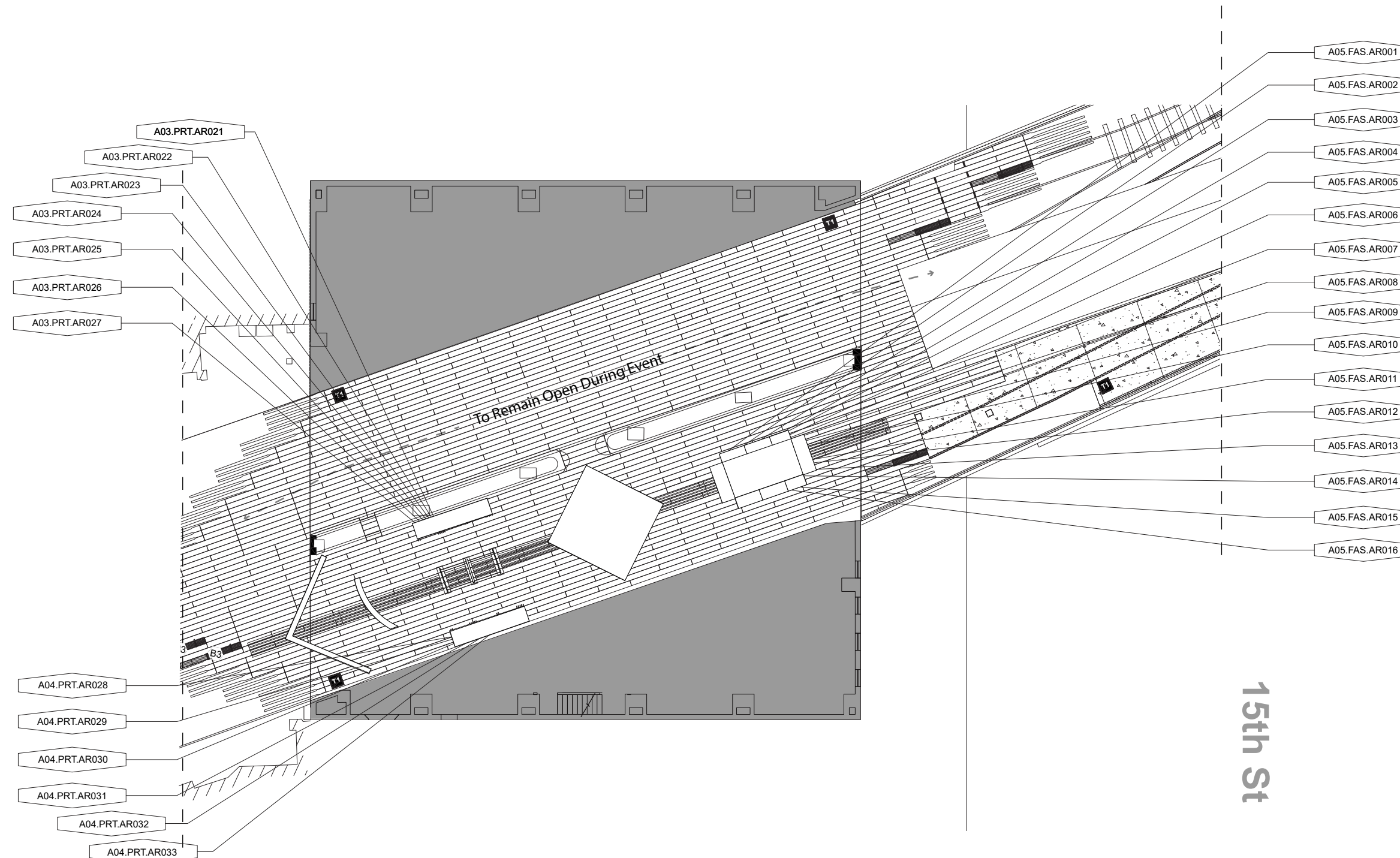

**1 SA OBJECT + ARTIFACT PLAN - 14TH STREET PASSAGE**  
Scale: 3/32" = 1'0"



These drawings are not for construction. This is an unpublished and proprietary work protected under copyright, trade secret, and like laws of the United States and other countries. All rights reserved.

These materials may not be reproduced, displayed, distributed, nor may be the information therein be used or disclosed in whole or in part, without the express written permission of Marlyka Williams.

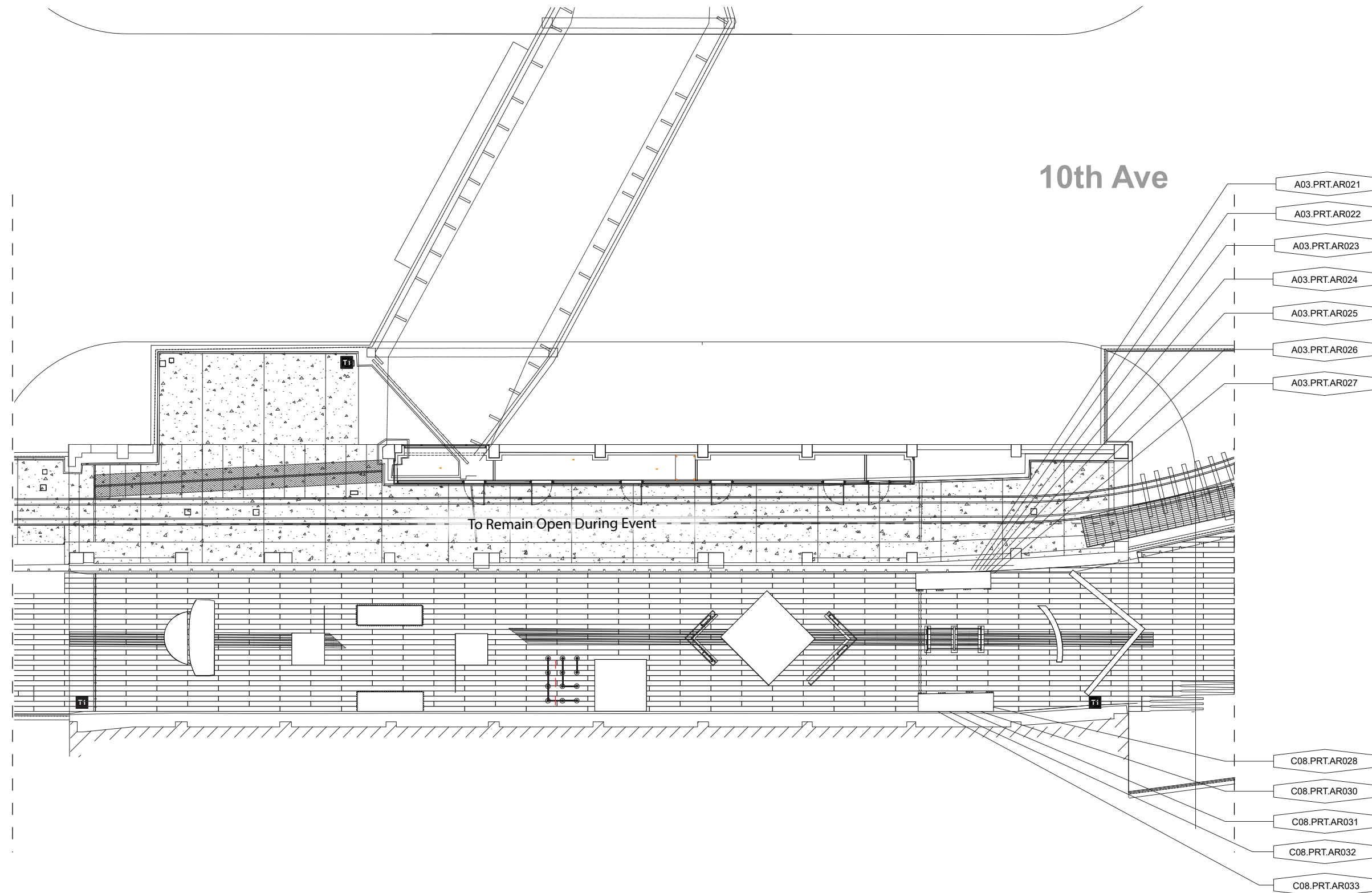
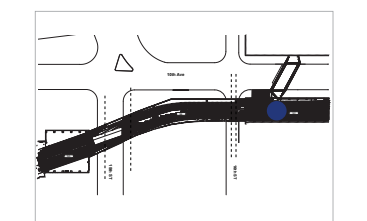

**1 SC OBJECT + ARTIFACT PLAN - CHELSEA PASSAGE**  
Scale: 3/32" = 1'-0"



These drawings are not for construction. This is an unpublished and proprietary work protected under copyright, trade secret, and like laws of the United States and other countries. All rights reserved.

These materials may not be reproduced, displayed, distributed, nor may be the information therein be used or disclosed in whole or in part, without the express written permission of Marlyka Williams.

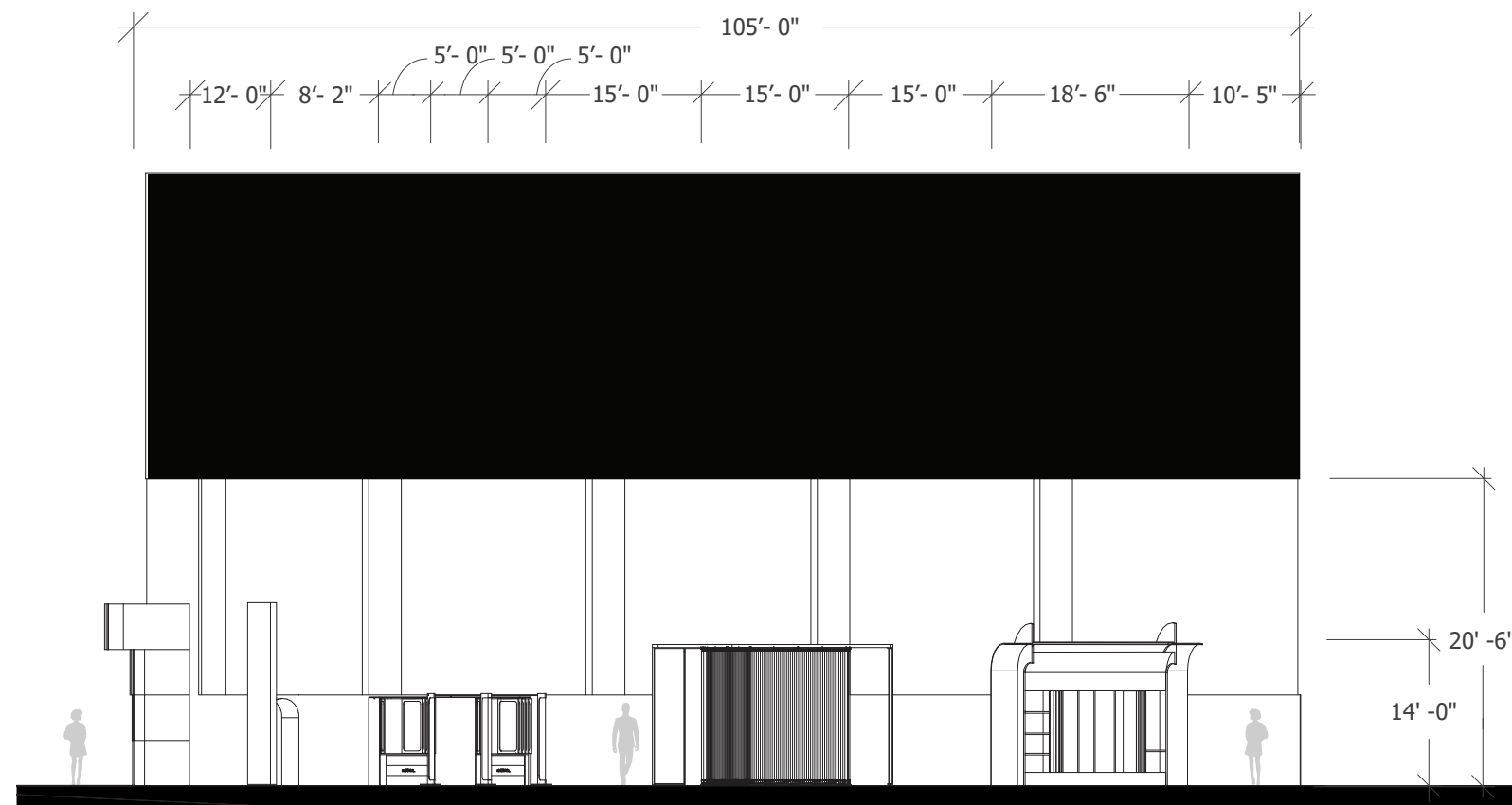
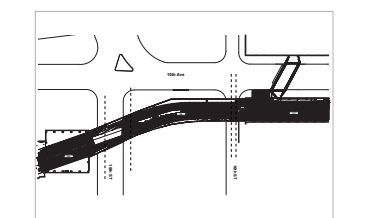

**1 SA WEST SECTION - 14TH STREET PASSAGE**  
Scale: 1/16" = 1'-0"

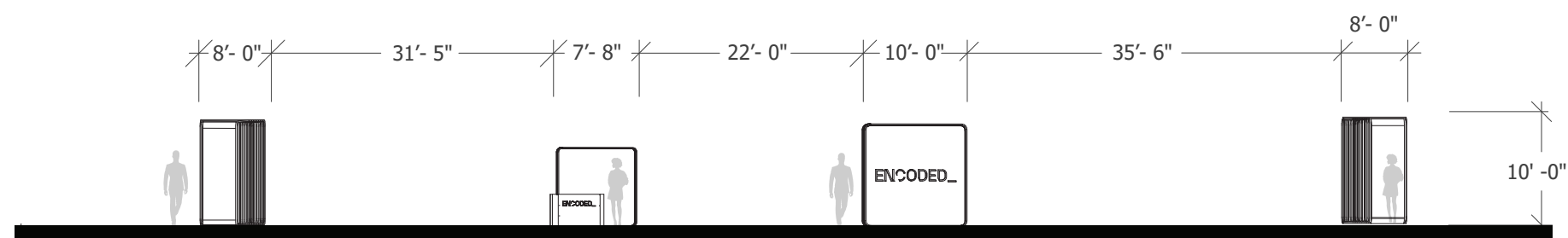

**2 SB WEST SECTION ELEVATION - DILLER VON FURSTENBERG SUNDECK**  
Scale: 1/16" = 1'-0"



**DISCLAIMER**

These drawings are not for construction. This is an unpublished and proprietary work protected under copyright, trade secret, and like laws of the United States and other countries. All rights reserved.

These materials may not be reproduced, displayed, distributed, nor may be the information therein be used or disclosed in whole or in part, without the express written permission of Marlyka Williams.

**KEY PLAN**

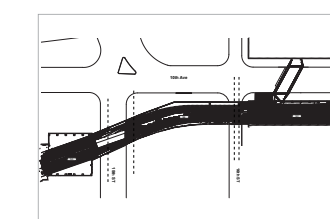

**DRAWN BY** MARLYKA WILLIAMS

**SCALE** 1/16" - 1-0"

**DATE** December 09, 2022

**DRAWING NAME**

SC Site Sections

**EX.03.17**

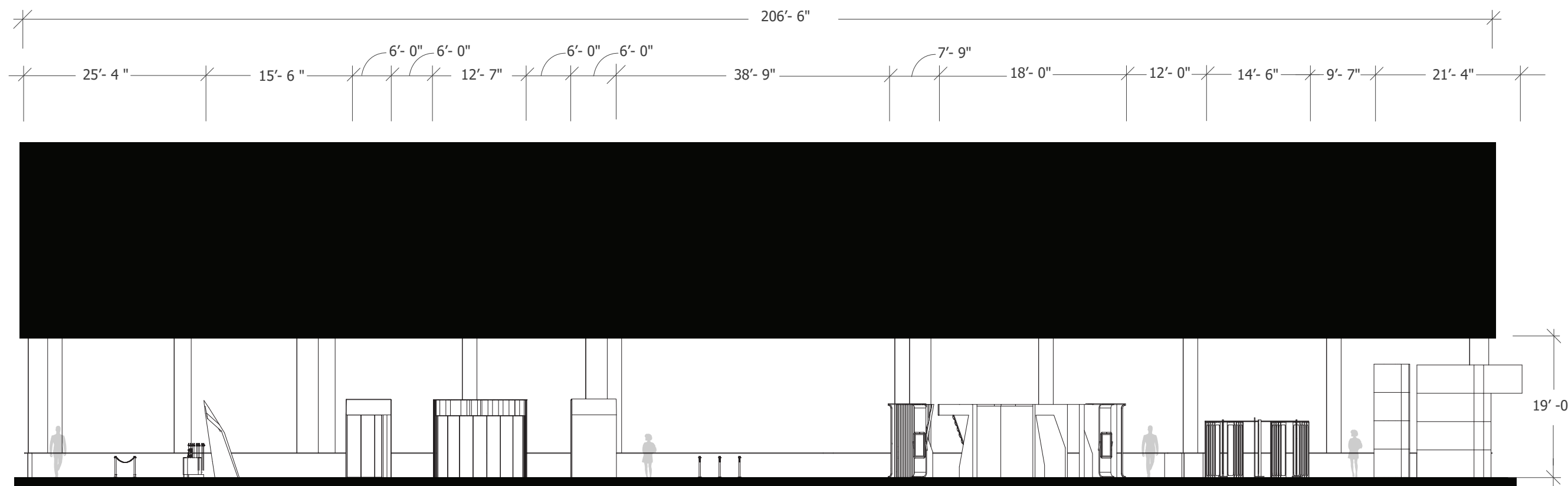

**1 SC WEST SECTION - CHELSEA PASSAGE**  
Scale: 1/16" = 1'-0"



# GRAPHIC SYSTEMS



**PROJECT**

**ENCODED\_**  
The Backend Data Experience

**CLIENT**

**BLACK MARKET  
FLEA**

**PARTNERSHIP + SUPPORT**



**DISCLAIMER**

These drawings are not for construction. This is an unpublished and proprietary work protected under copyright, trade secret, and like laws of the United States and other countries. All rights reserved.

These materials may not be reproduced, displayed, distributed, nor may be the information therein be used or disclosed in whole or in part, without the express written permission of Marlyka Williams.

**KEY PLAN**

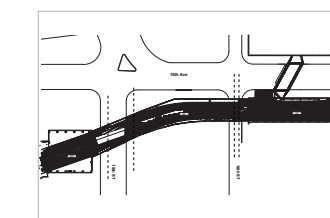

**DRAWN BY** MARLYKA WILLIAMS

**SCALE** NTS

**DATE** December 09, 2022

**DRAWING NAME**

Visual Communications Brief

**EX.04.01**

## VISUAL COMMUNICATION BRIEF

Inspired by the cylindrical shapes and circles found in the many “digital buttons” consumers regularly interact with throughout the day, the visual identity for Encoded: The Backend Data Experience takes a multi-layered approach, juxtaposing the micro and macro viewpoints of both consumers and big tech surrounding digital personalization.

Through transitional color gradations of indigo, fuchsia and cobalt, these colors were chosen to infer the tech driven environment and content which it is based upon. The visual references bears familiarity to data-driven binary coding, and is representative of the past and present Internet origins to that of its corporatization. Whereas fuchsia and purple colorways were utilized to represent the enjoyment of consumers when interacting with data-driven personalized content. These color combinations, paired with halftone image treatments and complimentary soft tone accents add bold pops of intrigue to the graphic hierarchy.

Similarly, Neue Machina Inktrap Regular is utilized as the title font, encompassing a distinctive minimal typographic design featuring mechanical subtleties that playfully allude to the sleek visual nature of coding. The complimentary, Open Sans Regular is then utilized for all body copy, boasting a large x-height for easy readability and overall cohesion to the exhibition’s

**LYKA WILLIAMS**

Exhibition & Experience Design

**FASHION INSTITUTE OF TECHNOLOGY**

School of Graduate Studies  
272 West 27th St  
New York, NY 10011

**PROJECT**

**ENCODED\_**  
The Backend Data Experience

**CLIENT**

**BLACK MARKET FLEA**

**PARTNERSHIP + SUPPORT**



**DISCLAIMER**

These drawings are not for construction. This is an unpublished and proprietary work protected under copyright, trade secret, and like laws of the United States and other countries. All rights reserved.

These materials may not be reproduced, displayed, distributed, nor may be the information therein be used or disclosed in whole or in part, without the express written permission of Marlyka Williams.

**KEY PLAN**

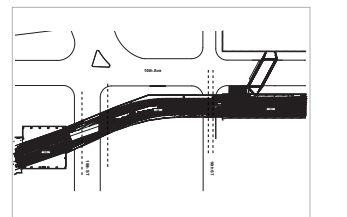

**DRAWN BY** MARLYKA WILLIAMS

**SCALE** NTS

**DATE** December 09, 2022

**DRAWING NAME**

Visual Identity Moodboard

**EX.04.02**

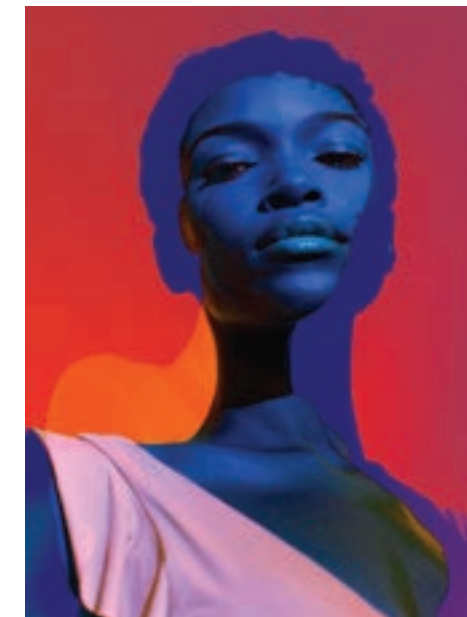
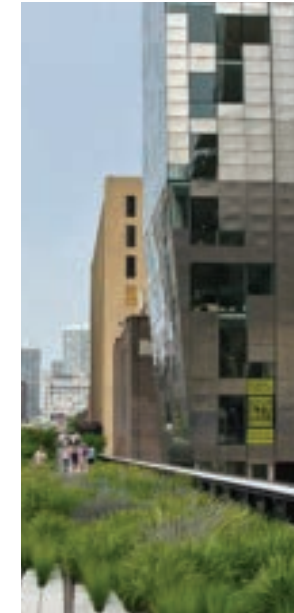
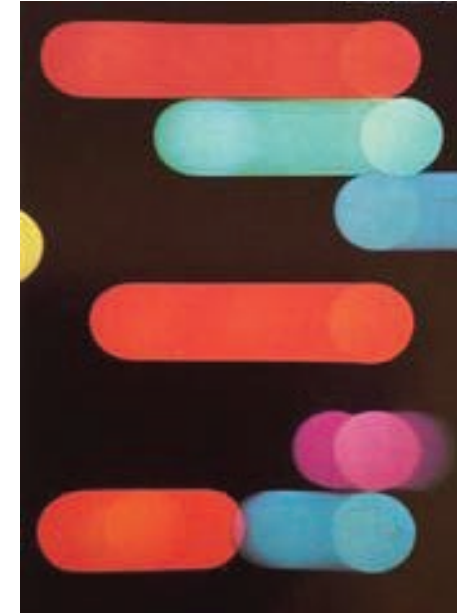
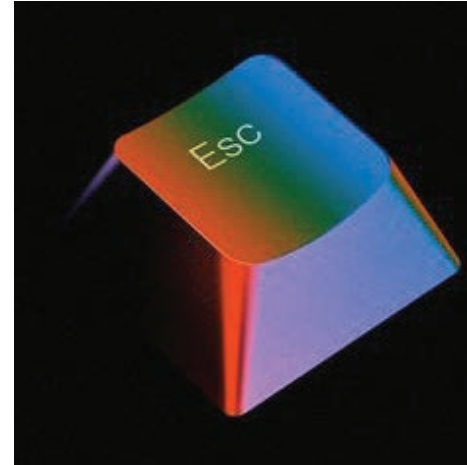

**LYKA WILLIAMS**

Exhibition & Experience Design

**FASHION INSTITUTE  
OF TECHNOLOGY**

School of Graduate Studies  
272 West 27th St  
New York, NY 10011

**PROJECT**

**ENCODED\_**  
The Backend Data Experience

**CLIENT**

**BLACK MARKET  
FLEA**

**PARTNERSHIP + SUPPORT**



**DISCLAIMER**

These drawings are not for construction. This is an unpublished and proprietary work protected under copyright, trade secret, and like laws of the United States and other countries. All rights reserved.

These materials may not be reproduced, displayed, distributed, nor may be the information therein be used or disclosed in whole or in part, without the express written permission of Marlyka Williams.

**KEY PLAN**

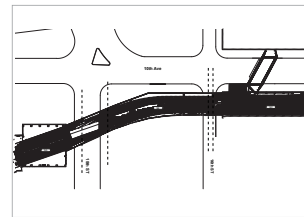

**DRAWN BY** MARLYKA WILLIAMS

**SCALE** NTS

**DATE** December 09, 2022

**DRAWING NAME**

Graphic Look + Feel

**EX.04.03**

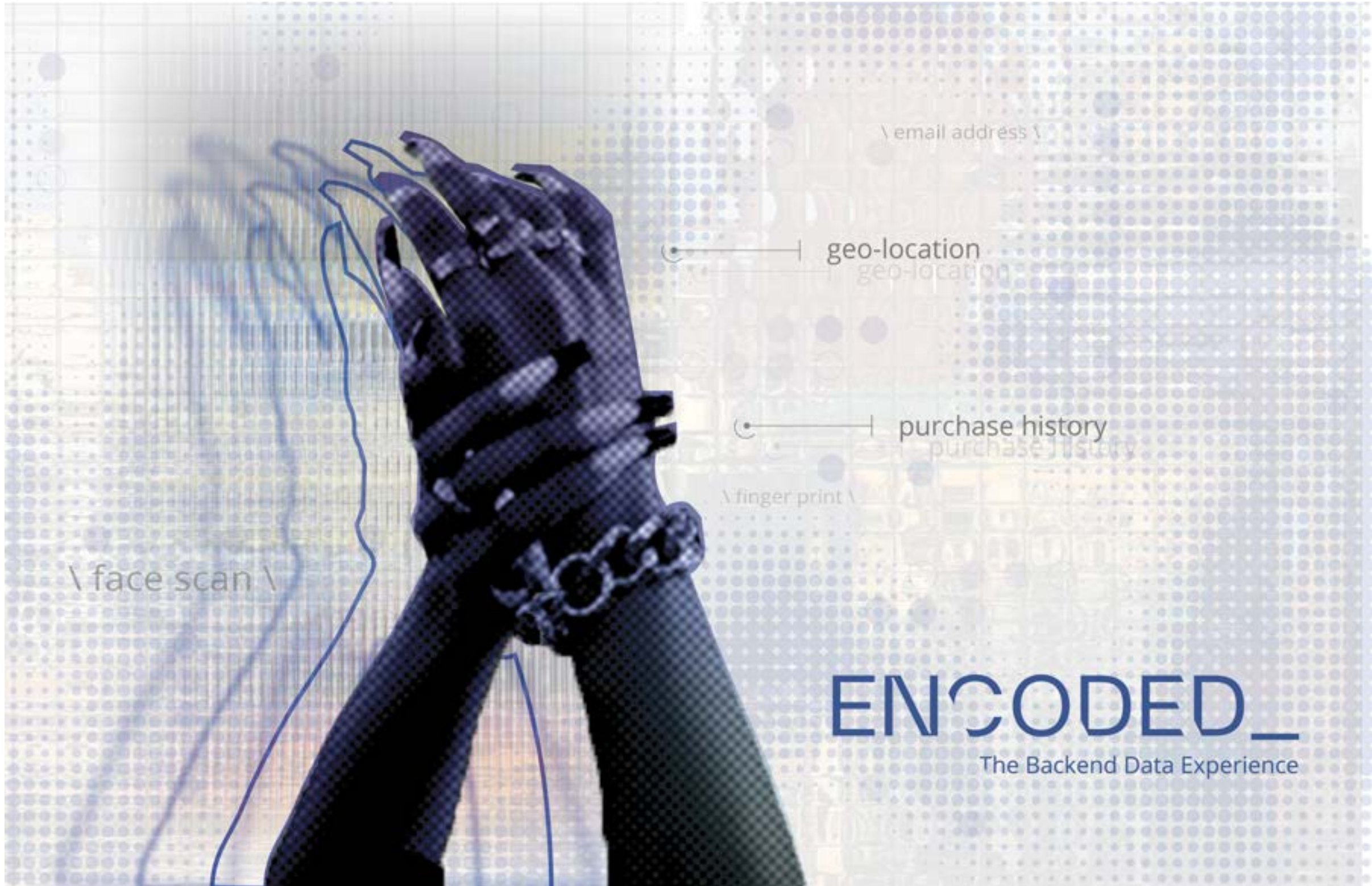



DISCLAIMER

These drawings are not for construction. This is an unpublished and proprietary work protected under copyright, trade secret, and like laws of the United States and other countries. All rights reserved.

These materials may not be reproduced, displayed, distributed, nor may be the information therein be used or disclosed in whole or in part, without the express written permission of Marlyka Williams.

KEY PLAN

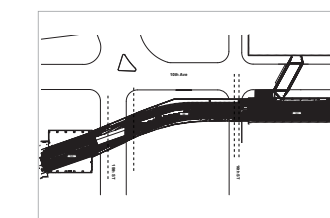

DRAWN BY MARLYKA WILLIAMS

SCALE NTS

DATE December 09, 2022

DRAWING NAME

Exhibition Identity Logo

EX.04.04

STACKED LOGO

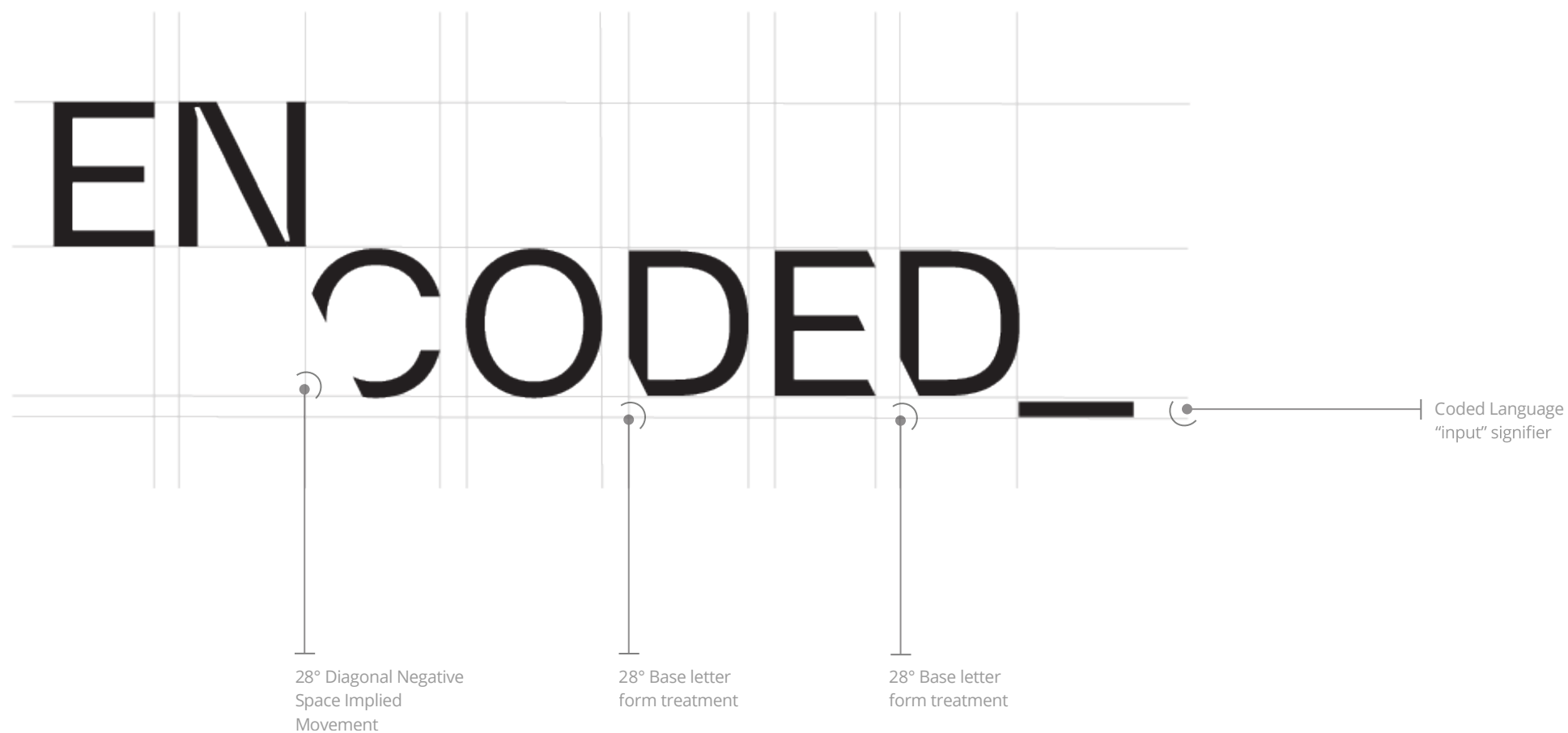

LOGO TEXT

TITLES

NEUE MACHINA INKTRAP REGULAR

ABCDEFGHIJKLMNOPQRSTUVWXYZ

abcdefghijklmnopqrstuvwxyz

0123456789!@#\$%^&\*()

SUBTITLES + BODY

SUBTITLES

OPEN SANS SEMIBOLD

ABCDEFGHIJKLMNOPQRSTUVWXYZ

abcdefghijklmnopqrstuvwxyz

0123456789!@#\$%^&\*()

BODY

OPEN SANS REGULAR

ABCDEFGHIJKLMNOPQRSTUVWXYZ

abcdefghijklmnopqrstuvwxyz

0123456789!@#\$%^&\*()

**PROJECT**

**ENCODED\_**  
The Backend Data Experience

**CLIENT**

**BLACK MARKET  
FLEA**

**PARTNERSHIP + SUPPORT**



**DISCLAIMER**

These drawings are not for construction. This is an unpublished and proprietary work protected under copyright, trade secret, and like laws of the United States and other countries. All rights reserved.

These materials may not be reproduced, displayed, distributed, nor may be the information therein be used or disclosed in whole or in part, without the express written permission of Marlyka Williams.

**KEY PLAN**

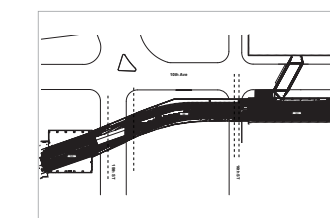

**DRAWN BY** MARLYKA WILLIAMS

**SCALE** NTS

**DATE** December 09, 2022

**DRAWING NAME**

Visual Patterns + Prints

**EX.04.05**

Dot Halftone  
Imagery

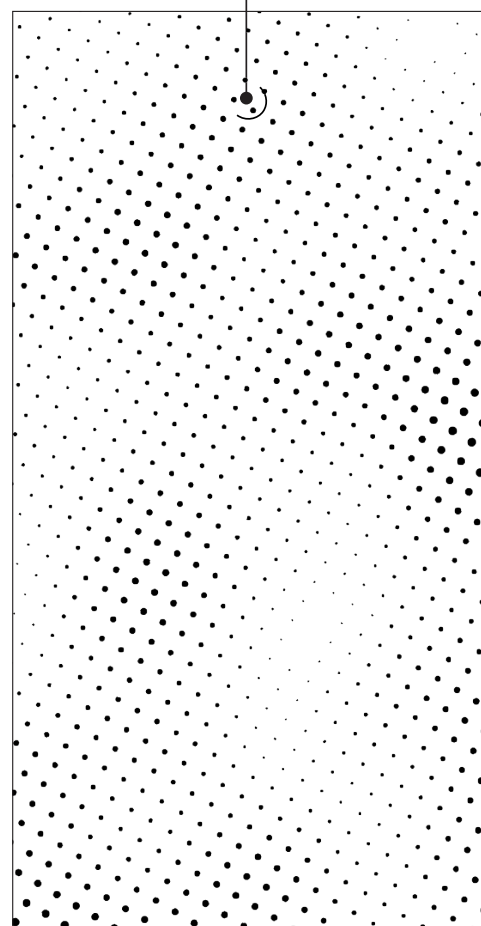

Color Grain  
Gradients



Binary Code Patterned  
1s + 0s



Graphic Symbol  
Linear Pattern

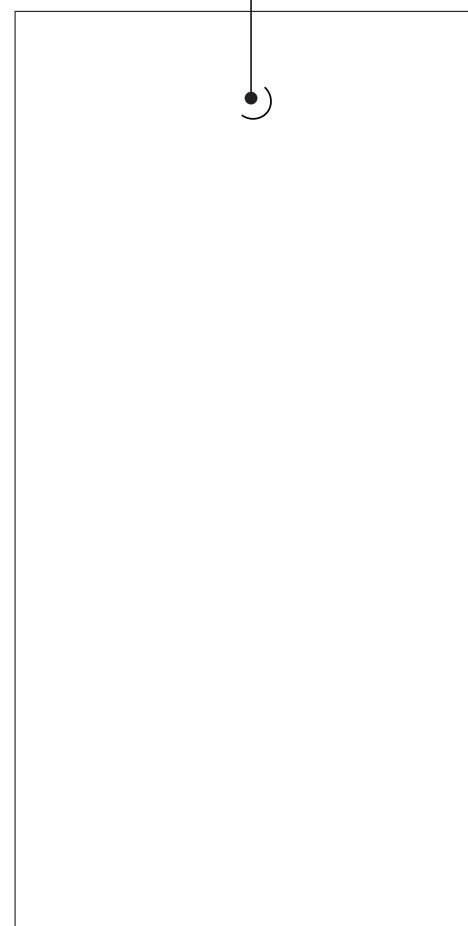

# LYKA WILLIAMS

Exhibition & Experience Design

## FASHION INSTITUTE OF TECHNOLOGY

School of Graduate Studies  
272 West 27th St  
New York, NY 10011

### PROJECT

**ENCODED\_**  
The Backend Data Experience

### CLIENT

**BLACK MARKET FLEA**

### PARTNERSHIP + SUPPORT



### DISCLAIMER

These drawings are not for construction. This is an unpublished and proprietary work protected under copyright, trade secret, and like laws of the United States and other countries. All rights reserved.

These materials may not be reproduced, displayed, distributed, nor may be the information therein be used or disclosed in whole or in part, without the express written permission of Marlyka Williams.

### KEY PLAN

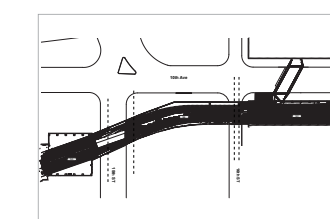

**DRAWN BY** MARLYKA WILLIAMS

**SCALE** NTS

**DATE** December 09, 2022

### DRAWING NAME

Color Palette

# EX.04.06

### PRIMARY COLOR PALETTE



### BIG TECH PERSPECTIVE



### CONSUMER PERSPECTIVE



**LYKA WILLIAMS**

Exhibition & Experience Design

**FASHION INSTITUTE OF TECHNOLOGY**

School of Graduate Studies  
272 West 27th St  
New York, NY 10011

**PROJECT**

**ENCODED\_**  
The Backend Data Experience

**CLIENT**

**BLACK MARKET FLEA**

**PARTNERSHIP + SUPPORT**



**DISCLAIMER**

These drawings are not for construction. This is an unpublished and proprietary work protected under copyright, trade secret, and like laws of the United States and other countries. All rights reserved.

These materials may not be reproduced, displayed, distributed, nor may be the information therein be used or disclosed in whole or in part, without the express written permission of Marlyka Williams.

**KEY PLAN**

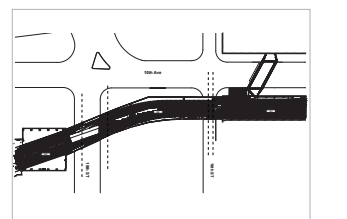

**DRAWN BY** MARLYKA WILLIAMS

**SCALE** NTS

**DATE** December 09, 2022

**DRAWING NAME**

Exhibition Posters

**EX.04.07**

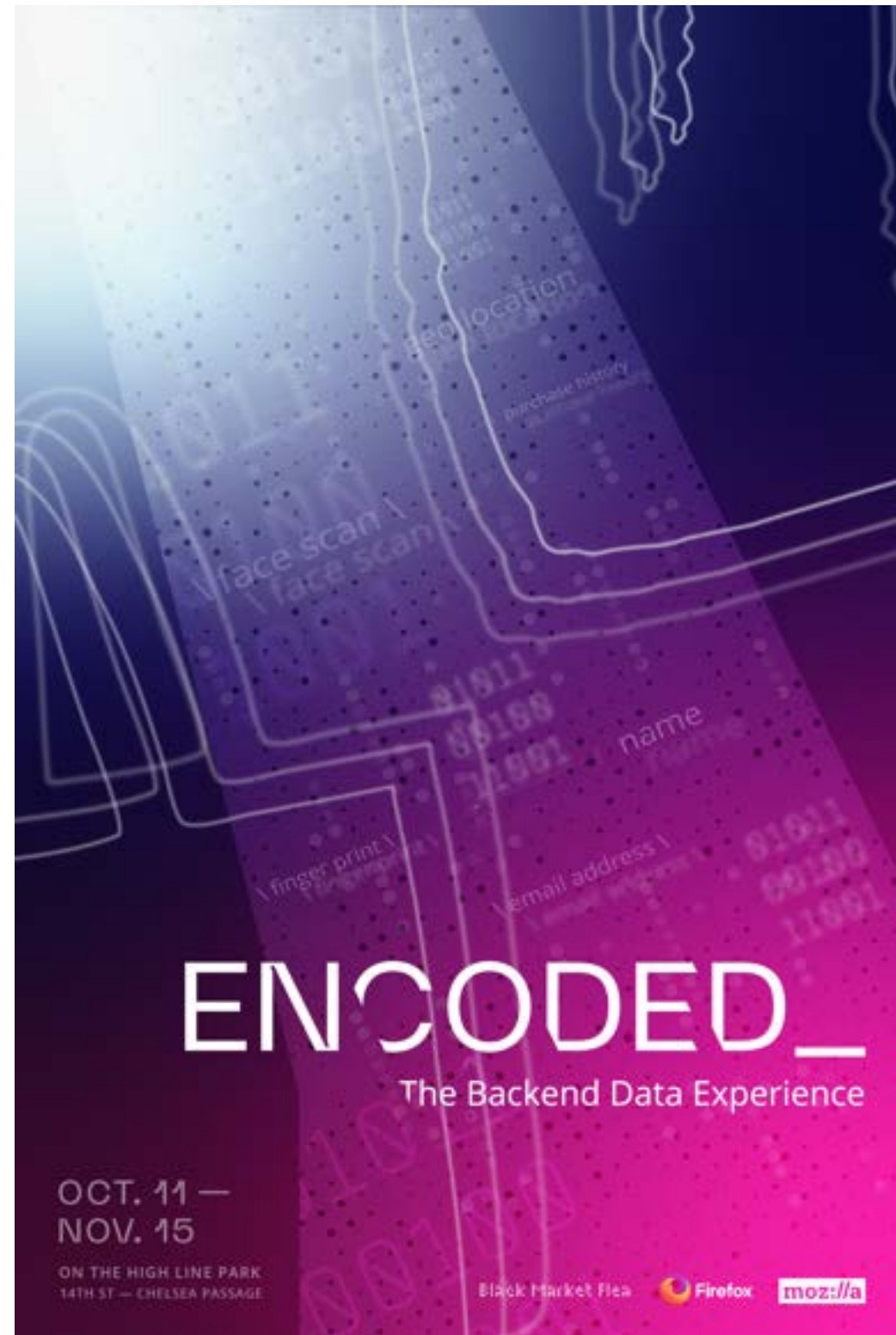

# LYKA WILLIAMS

Exhibition & Experience Design

## FASHION INSTITUTE OF TECHNOLOGY

School of Graduate Studies  
272 West 27th St  
New York, NY 10011

### PROJECT

**ENCODED\_**  
The Backend Data Experience

### CLIENT

**BLACK MARKET FLEA**

### PARTNERSHIP + SUPPORT



### DISCLAIMER

These drawings are not for construction. This is an unpublished and proprietary work protected under copyright, trade secret, and like laws of the United States and other countries. All rights reserved.

These materials may not be reproduced, displayed, distributed, nor may be the information therein be used or disclosed in whole or in part, without the express written permission of Marlyka Williams.

### KEY PLAN

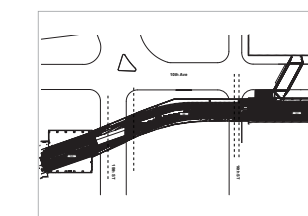

**DRAWN BY** MARLYKA WILLIAMS

**SCALE** NTS

**DATE** December 09, 2022

### DRAWING NAME

Pre Visit Strategy I

# EX.04.08

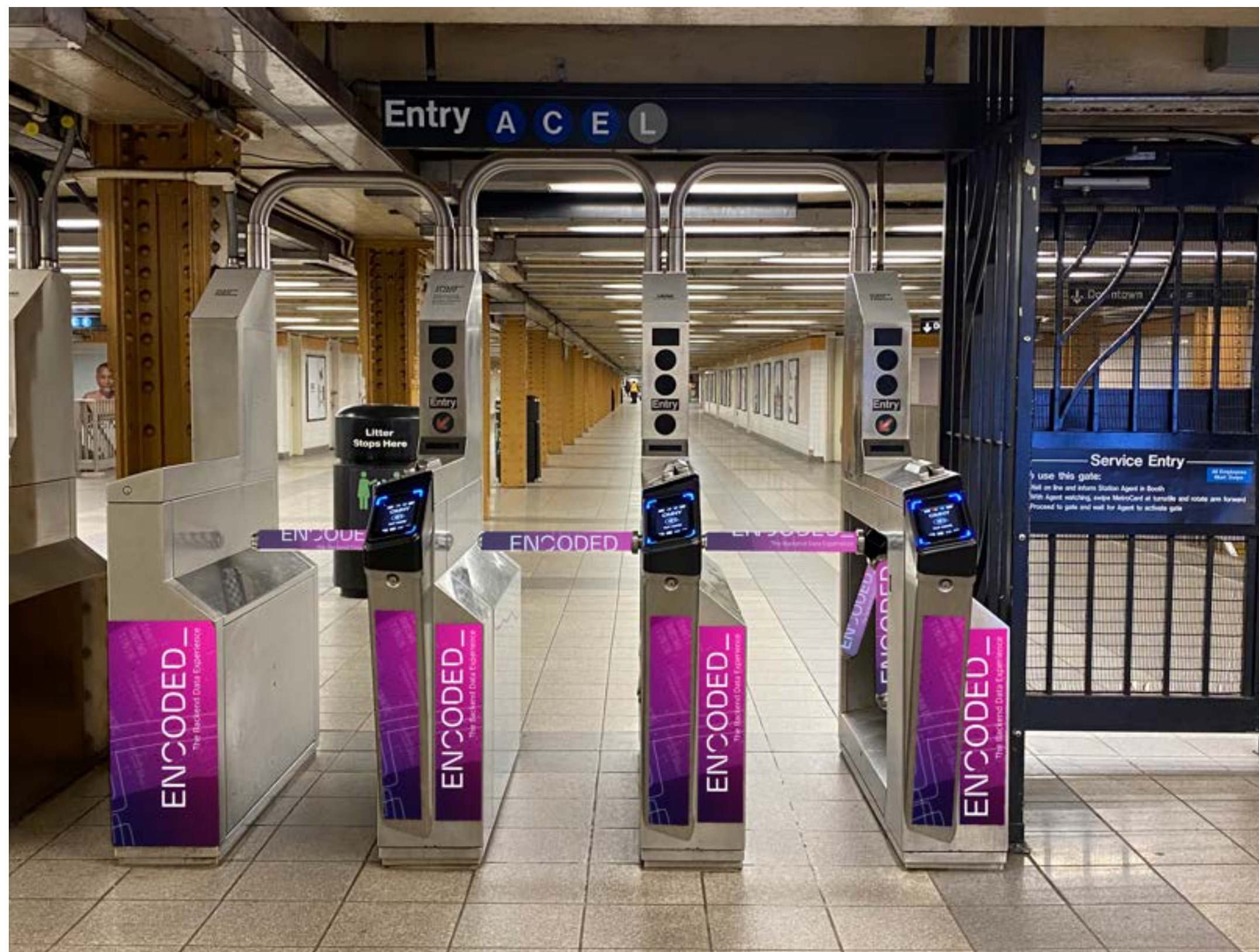



# LYKA WILLIAMS

Exhibition & Experience Design

## FASHION INSTITUTE OF TECHNOLOGY

School of Graduate Studies  
272 West 27th St  
New York, NY 10011

### PROJECT

**ENCODED\_**  
The Backend Data Experience

### CLIENT

**BLACK MARKET FLEA**

### PARTNERSHIP + SUPPORT



### DISCLAIMER

These drawings are not for construction. This is an unpublished and proprietary work protected under copyright, trade secret, and like laws of the United States and other countries. All rights reserved.

These materials may not be reproduced, displayed, distributed, nor may be the information therein be used or disclosed in whole or in part, without the express written permission of Marlyka Williams.

### KEY PLAN

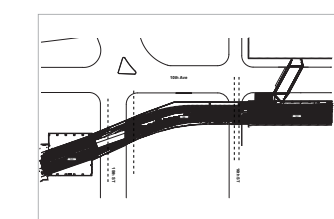

**DRAWN BY** MARLYKA WILLIAMS

**SCALE** NTS

**DATE** December 09, 2022

**DRAWING NAME**

Pre Visit Strategy II

**EX.04.09**





# LYKA WILLIAMS

Exhibition & Experience Design

## FASHION INSTITUTE OF TECHNOLOGY

School of Graduate Studies  
272 West 27th St  
New York, NY 10011

### PROJECT

**ENCODED\_**  
The Backend Data Experience

### CLIENT

**BLACK MARKET FLEA**

### PARTNERSHIP + SUPPORT



### DISCLAIMER

These drawings are not for construction. This is an unpublished and proprietary work protected under copyright, trade secret, and like laws of the United States and other countries. All rights reserved.

These materials may not be reproduced, displayed, distributed, nor may be the information therein be used or disclosed in whole or in part, without the express written permission of Marlyka Williams.

### KEY PLAN

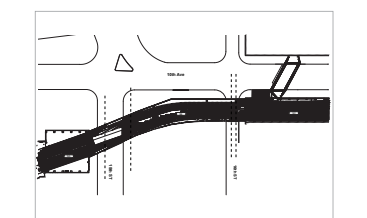

**DRAWN BY** MARLYKA WILLIAMS

**SCALE** NTS

**DATE** December 09, 2022

### DRAWING NAME

Pre Visit Strategy III

**EX.04.10**



These drawings are not for construction. This is an unpublished and proprietary work protected under copyright, trade secret, and like laws of the United States and other countries. All rights reserved.

These materials may not be reproduced, displayed, distributed, nor may be the information therein be used or disclosed in whole or in part, without the express written permission of Marlyka Williams.

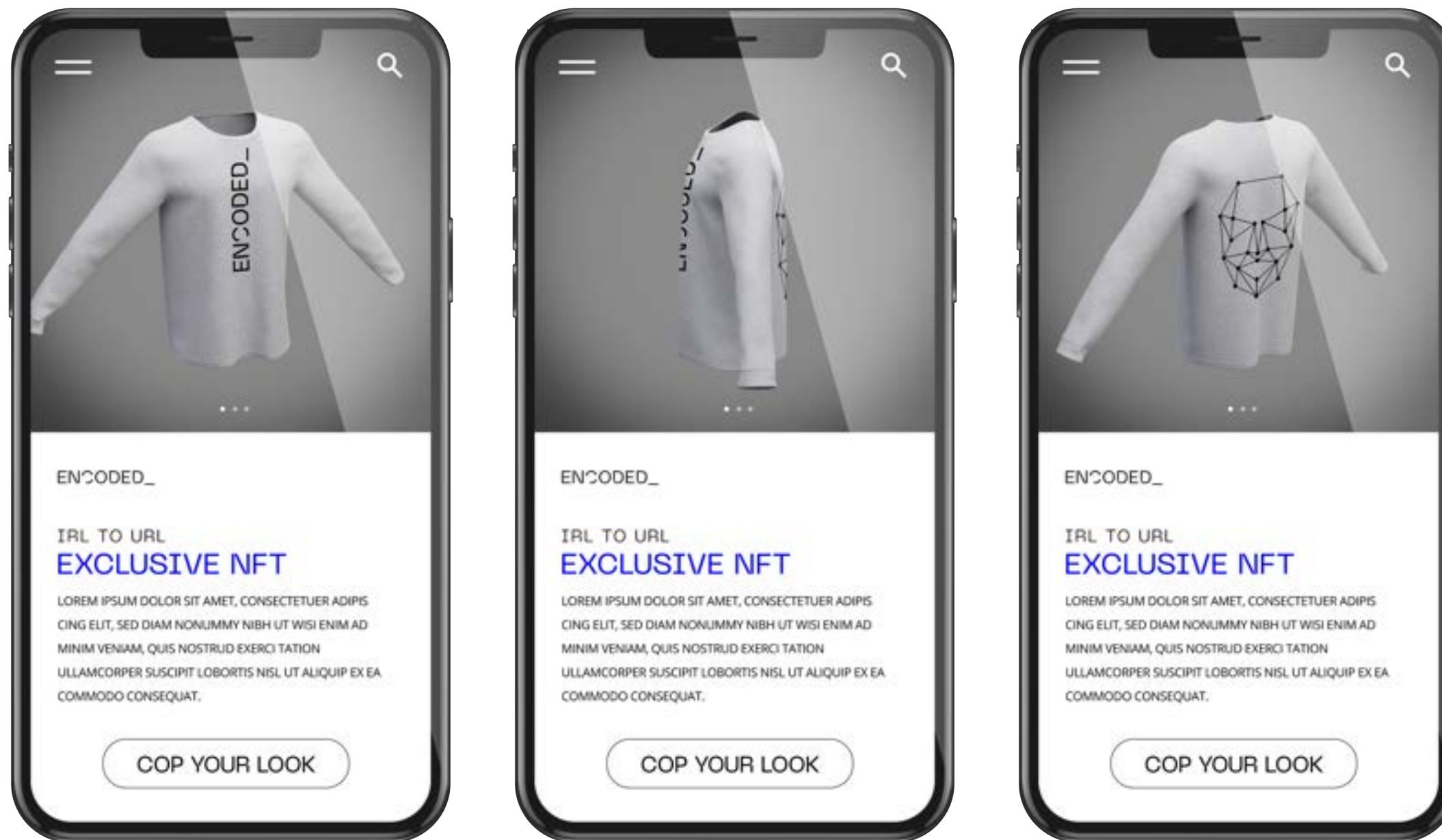
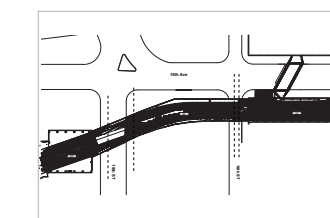

## EXHIBITION COLLATERAL

Within the pop-up, visitors are prompted to take a biometric face scan to engage with one of the main experiences within the event. From this scan, they can opt to receive their very own one of a kind exhibition merchandise featuring their stylized face print as the graphic treatment. This is also incorporated as NFT, offering the exclusive digital merchandise range for their metaverse avatars as well.

# LYKA WILLIAMS

Exhibition & Experience Design

## FASHION INSTITUTE OF TECHNOLOGY

School of Graduate Studies  
272 West 27th St  
New York, NY 10011

### PROJECT

**ENCODED\_**  
The Backend Data Experience

### CLIENT

**BLACK MARKET  
FLEA**

### PARTNERSHIP + SUPPORT



### DISCLAIMER

These drawings are not for construction. This is an unpublished and proprietary work protected under copyright, trade secret, and like laws of the United States and other countries. All rights reserved.

These materials may not be reproduced, displayed, distributed, nor may be the information therein be used or disclosed in whole or in part, without the express written permission of Marlyka Williams.

### KEY PLAN

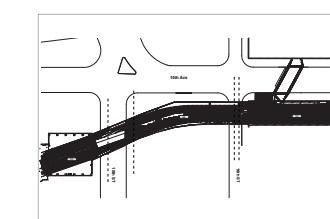

**DRAWN BY** MARLYKA WILLIAMS

**SCALE** NTS

**DATE** December 09, 2022

### DRAWING NAME

Exhibition Collateral II

# EX.04.12

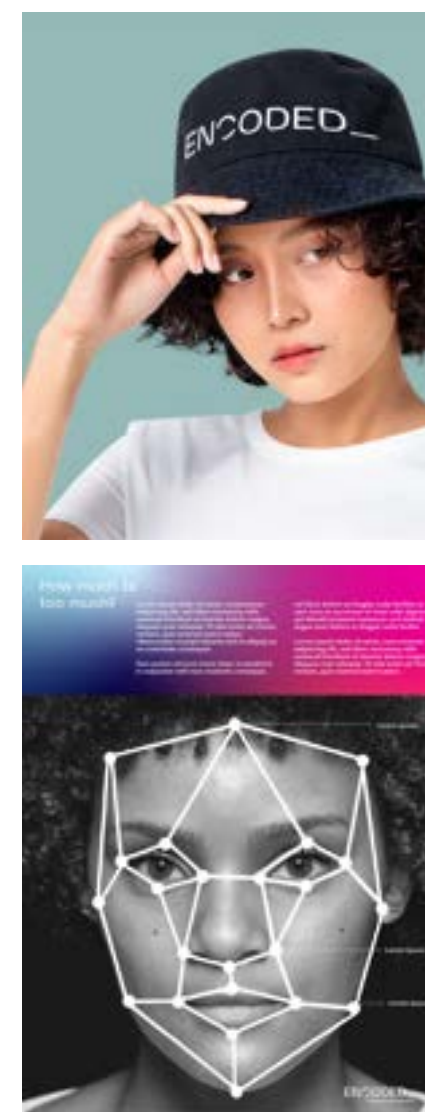

## EXHIBITION COLLATERAL

The face scan graphic sweatshirt will be screen printed and shipped to each participant along with an accompanied informational pamphlet to further provide educational content in relation to biometric data security in our digital age. Participants, who opted-out of generating their face scan in the exhibit will have the opportunity to select from the option ranges of other branded merchandise on site.

# LYKA WILLIAMS

Exhibition & Experience Design

## FASHION INSTITUTE OF TECHNOLOGY

School of Graduate Studies  
272 West 27th St  
New York, NY 10011

### PROJECT

**ENCODED\_**  
The Backend Data Experience

### CLIENT

**BLACK MARKET  
FLEA**

### PARTNERSHIP + SUPPORT



### DISCLAIMER

These drawings are not for construction. This is an unpublished and proprietary work protected under copyright, trade secret, and like laws of the United States and other countries. All rights reserved.

These materials may not be reproduced, displayed, distributed, nor may be the information therein be used or disclosed in whole or in part, without the express written permission of Marlyka Williams.

### KEY PLAN

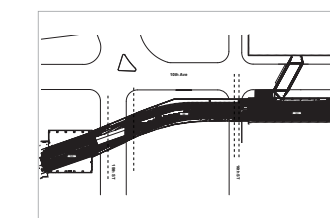

**DRAWN BY** MARLYKA WILLIAMS

**SCALE** NTS

**DATE** December 09, 2022

**DRAWING NAME**

Docent Attire

# EX.04.13



## DOCENT ATTIRE

Throughout the experience, affiliated exhibition docents will be present to assist visitors perform various transactions throughout the on site shoppable zones, as well as stationed within the technology driven activity areas. These guides will be dressed in the displayed attire as depicted above with the option to bring in their unique style through their choice of paired outerwear.

# LYKA WILLIAMS

Exhibition & Experience Design

## FASHION INSTITUTE OF TECHNOLOGY

School of Graduate Studies  
272 West 27th St  
New York, NY 10011

### PROJECT

# ENCODED\_

The Backend Data Experience

### CLIENT

# BLACK MARKET FLEA

### PARTNERSHIP + SUPPORT



### DISCLAIMER

These drawings are not for construction. This is an unpublished and proprietary work protected under copyright, trade secret, and like laws of the United States and other countries. All rights reserved.

These materials may not be reproduced, displayed, distributed, nor may be the information therein be used or disclosed in whole or in part, without the express written permission of Marlyka Williams.

### KEY PLAN

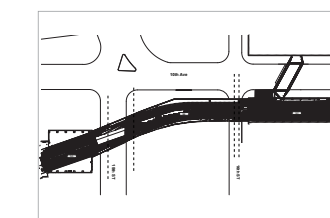

**DRAWN BY** MARLYKA WILLIAMS

**SCALE** NTS

**DATE** December 09, 2022

**DRAWING NAME**

Graphic Family

# EX.04.14





# EXHIBITION DETAILING





These drawings are not for construction. This is an unpublished and proprietary work protected under copyright, trade secret, and like laws of the United States and other countries. All rights reserved.

These materials may not be reproduced, displayed, distributed, nor may be the information therein be used or disclosed in whole or in part, without the express written permission of Marlyka Williams.

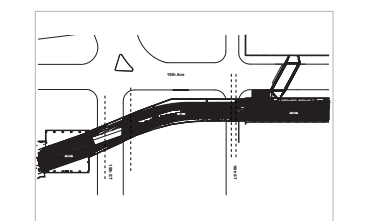

**1 A00.GR11 TOP VIEW** I  
Scale: 3/4" = 1'-0"

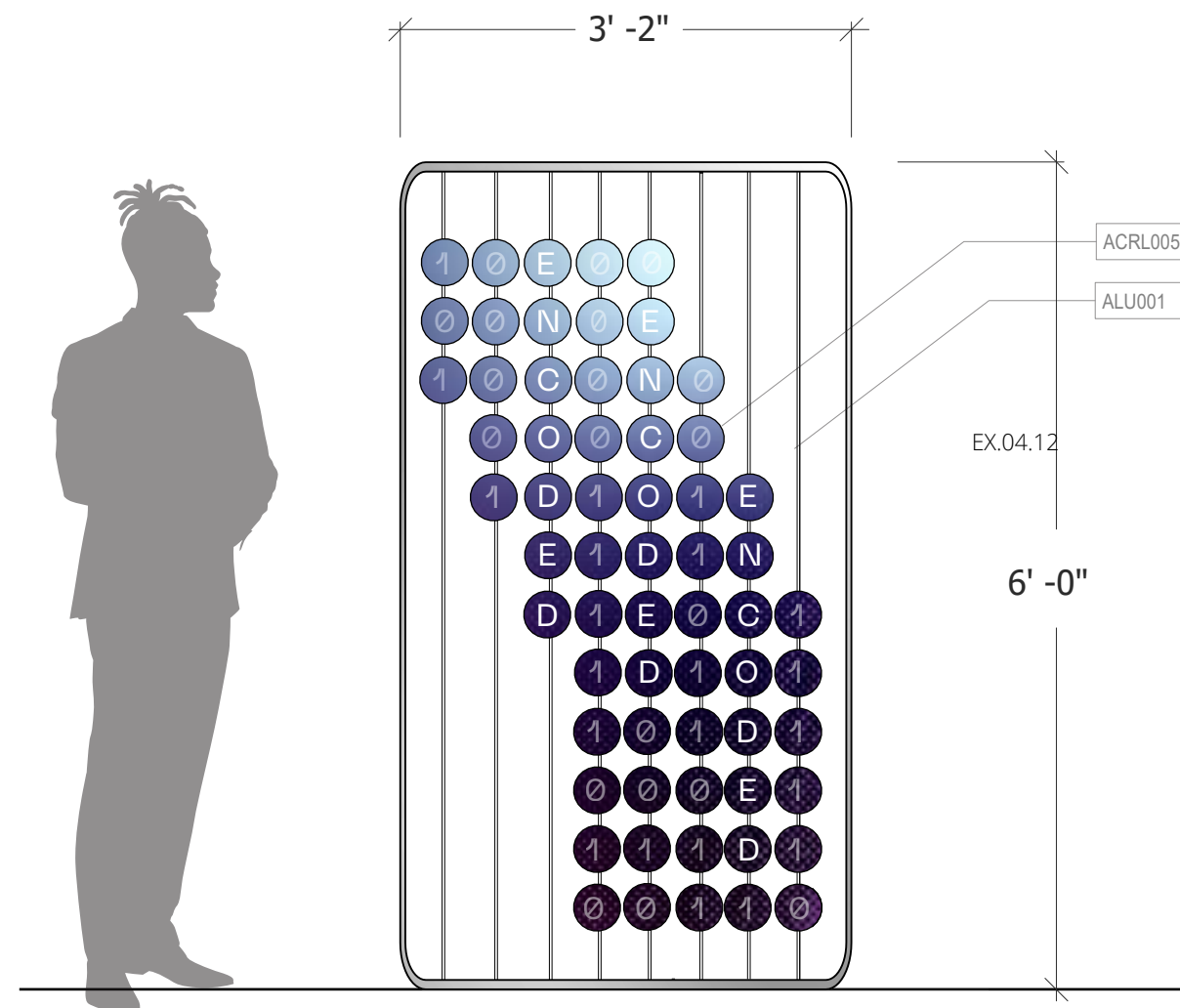

**2 A00.GR11 ELEVATION** I  
Scale: 3/4" = 1'-0"

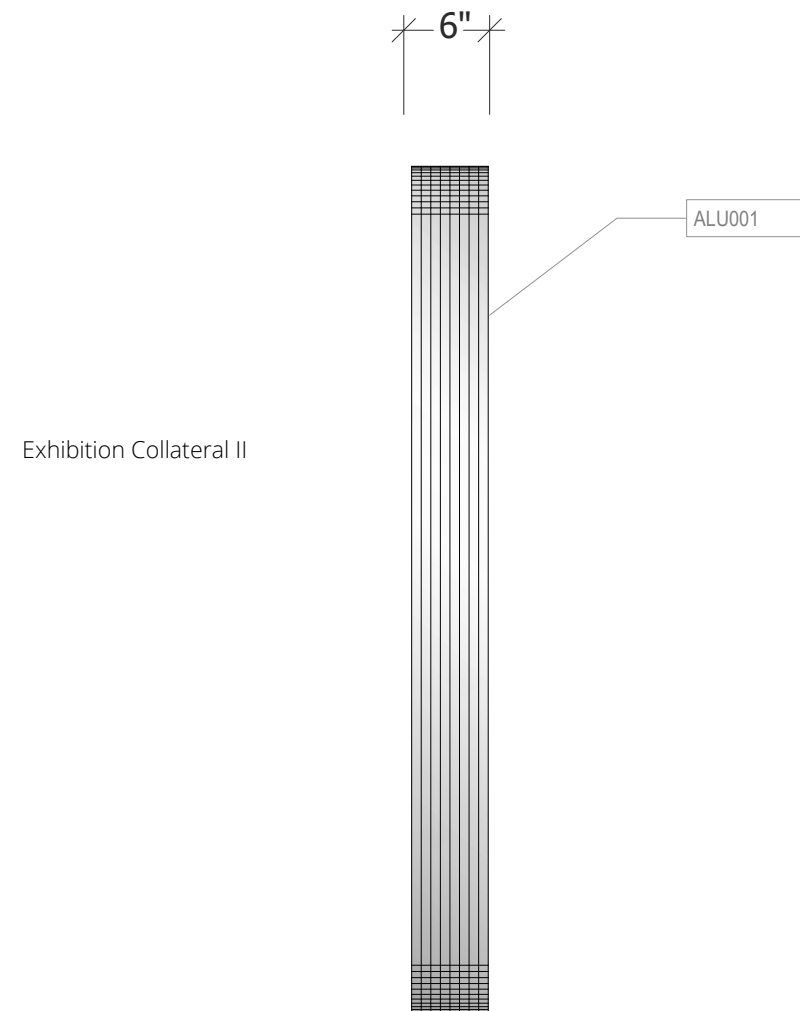

**3 A00.GR11 SIDE PROFILE** I  
Scale: 3/4" = 1'-0"

# LYKA WILLIAMS

Exhibition & Experience Design

## FASHION INSTITUTE OF TECHNOLOGY

School of Graduate Studies  
272 West 27th St  
New York, NY 10011

### PROJECT

# ENCODED\_

The Backend Data Experience

### CLIENT

# BLACK MARKET FLEA

### PARTNERSHIP + SUPPORT



### DISCLAIMER

These drawings are not for construction. This is an unpublished and proprietary work protected under copyright, trade secret, and like laws of the United States and other countries. All rights reserved.

These materials may not be reproduced, displayed, distributed, nor may be the information therein be used or disclosed in whole or in part, without the express written permission of Marlyka Williams.

### KEY PLAN

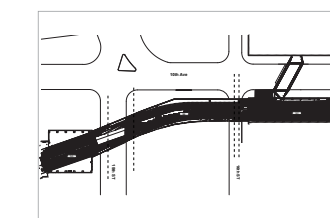

**DRAWN BY** MARLYKA WILLIAMS

**SCALE** 3/4" = 1'-0"

**DATE** December 09, 2022

**DRAWING NAME**

Wayfinding II

# EX.05.02

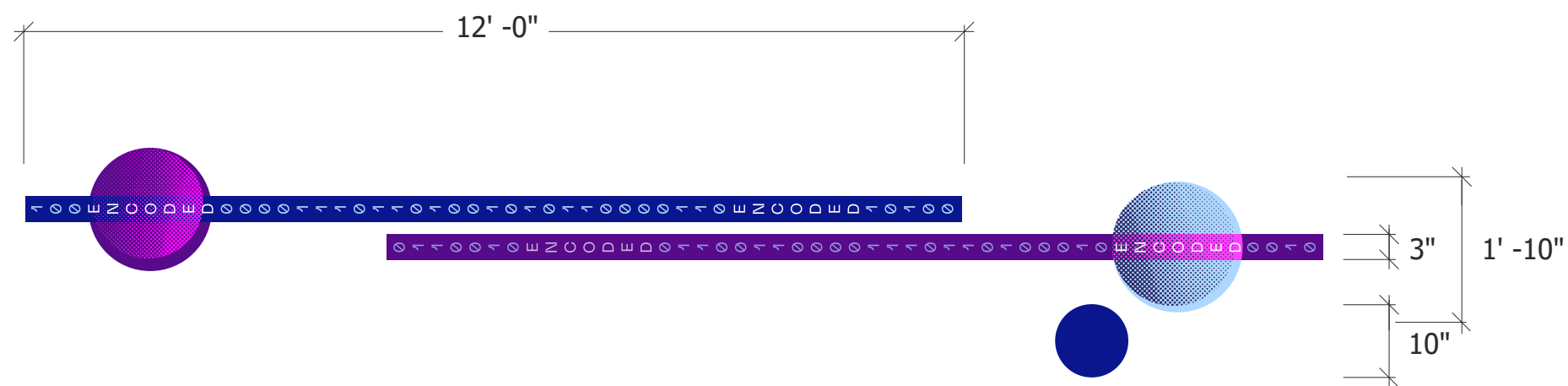

1

A00.GR01  
Scale: 1/2" = 1'-0"

TOP VIEW

F

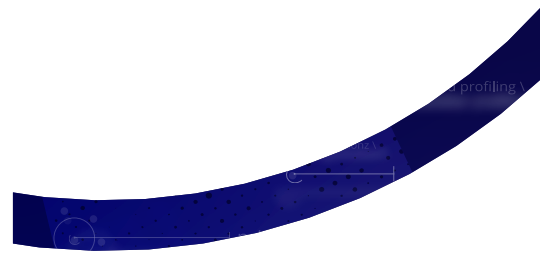

1 A01.GR01 TOP VIEW H  
Scale: 1/4" = 1'-0"

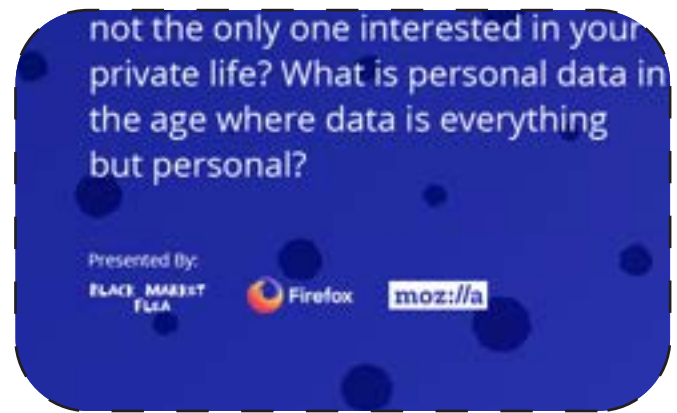

2 A01.GR01 ELEVATION H  
Scale: 1/4" = 1'-0"

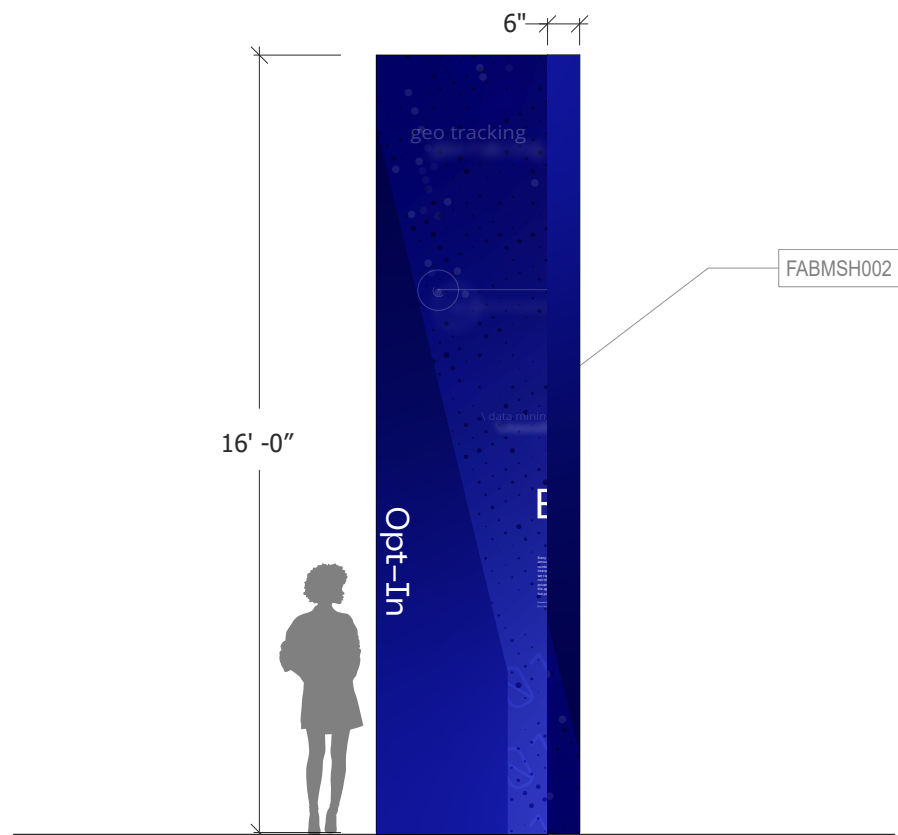

3 A01.GR01 SIDE PROFILE H  
Scale: 1/4" = 1'-0"

**LYKA WILLIAMS**  
Exhibition & Experience Design

**FASHION INSTITUTE OF TECHNOLOGY**  
School of Graduate Studies  
272 West 27th St  
New York, NY 10011

**PROJECT**  
**ENCODED\_**  
The Backend Data Experience

**CLIENT**  
**BLACK MARKET FLEA**

**PARTNERSHIP + SUPPORT**  
Firefox moz://a

**DISCLAIMER**  
These drawings are not for construction. This is an unpublished and proprietary work protected under copyright, trade secret, and like laws of the United States and other countries. All rights reserved.  
  
These materials may not be reproduced, displayed, distributed, nor may be the information therein be used or disclosed in whole or in part, without the express written permission of Marlyka Williams.

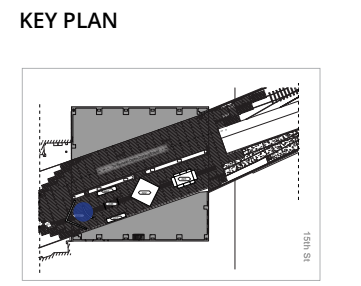

**DRAWN BY** MARLYKA WILLIAMS  
**SCALE** 1/4" = 1'-0"  
**DATE** December 09, 2022

**DRAWING NAME**  
Introduction  
**EX.05.03**

# LYKA WILLIAMS

Exhibition & Experience Design

## FASHION INSTITUTE OF TECHNOLOGY

School of Graduate Studies  
272 West 27th St  
New York, NY 10011

### PROJECT

# ENCODED\_

The Backend Data Experience

### CLIENT

# BLACK MARKET FLEA

### PARTNERSHIP + SUPPORT



### DISCLAIMER

These drawings are not for construction. This is an unpublished and proprietary work protected under copyright, trade secret, and like laws of the United States and other countries. All rights reserved.

These materials may not be reproduced, displayed, distributed, nor may be the information therein be used or disclosed in whole or in part, without the express written permission of Marlyka Williams.

### KEY PLAN

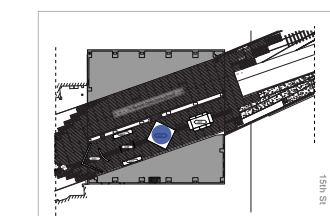

DRAWN BY MARLYKA WILLIAMS

SCALE 1/2" = 1'-0"

DATE December 09, 2022

DRAWING NAME

Exhibit Content I

# EX.05.04

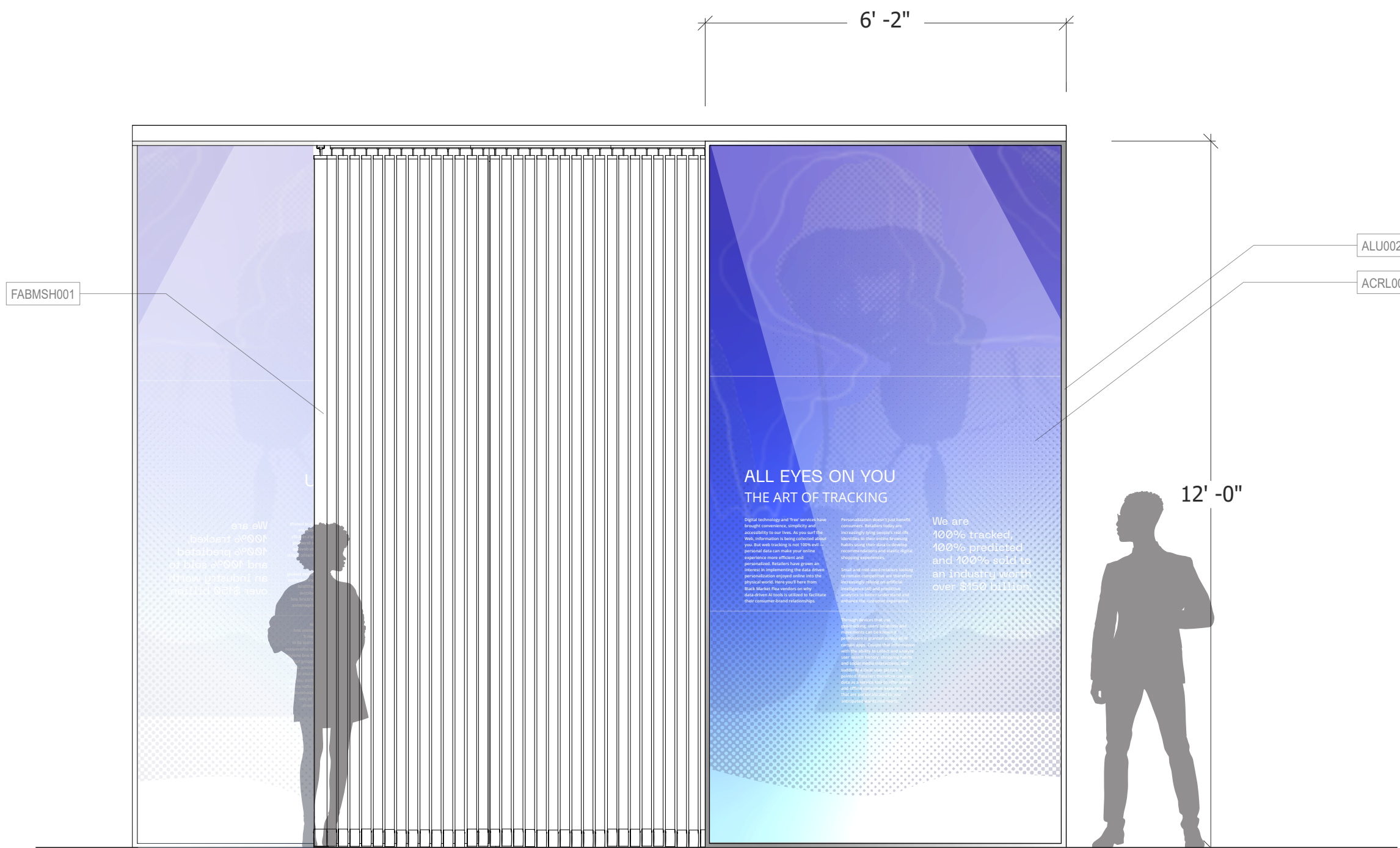

1 A02.GR17 ELEVATION B  
Scale: 1/2" = 1'-0"

# LYKA WILLIAMS

Exhibition & Experience Design

## FASHION INSTITUTE OF TECHNOLOGY

School of Graduate Studies  
272 West 27th St  
New York, NY 10011

### PROJECT

**ENCODED\_**  
The Backend Data Experience

### CLIENT

**BLACK MARKET FLEA**

### PARTNERSHIP + SUPPORT



### DISCLAIMER

These drawings are not for construction. This is an unpublished and proprietary work protected under copyright, trade secret, and like laws of the United States and other countries. All rights reserved.

These materials may not be reproduced, displayed, distributed, nor may be the information therein be used or disclosed in whole or in part, without the express written permission of Marlyka Williams.

### KEY PLAN

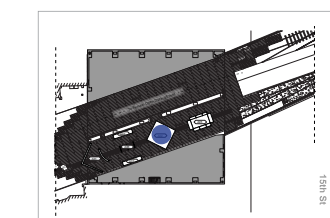

**DRAWN BY** MARLYKA WILLIAMS

**SCALE** 1/2" = 1'-0"

**DATE** December 09, 2022

**DRAWING NAME**

Exhibit Content II

# EX.05.05

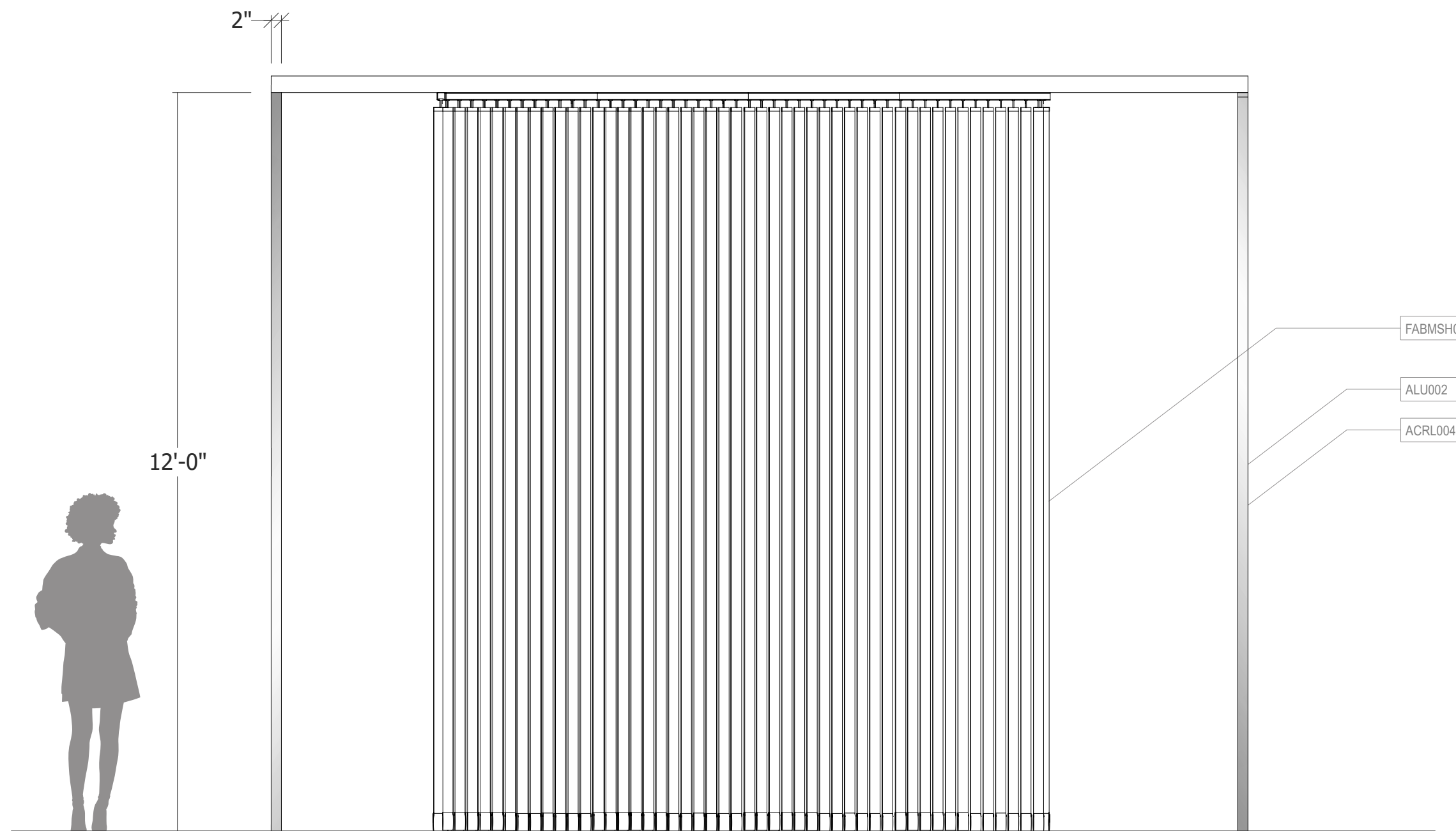

1 A02.GR17 SIDE PROFILE B  
Scale: 1/2" = 1'-0"

# LYKA WILLIAMS

Exhibition & Experience Design

## FASHION INSTITUTE OF TECHNOLOGY

School of Graduate Studies  
272 West 27th St  
New York, NY 10011

### PROJECT

**ENCODED\_**  
The Backend Data Experience

### CLIENT

**BLACK MARKET FLEA**

### PARTNERSHIP + SUPPORT



### DISCLAIMER

These drawings are not for construction. This is an unpublished and proprietary work protected under copyright, trade secret, and like laws of the United States and other countries. All rights reserved.

These materials may not be reproduced, displayed, distributed, nor may be the information therein be used or disclosed in whole or in part, without the express written permission of Marlyka Williams.

### KEY PLAN

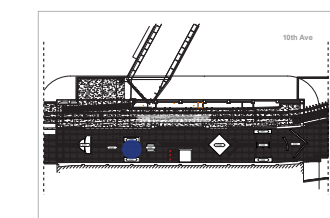

**DRAWN BY** MARLYKA WILLIAMS

**SCALE** 1/2" = 1'-0"

**DATE** December 09, 2022

**DRAWING NAME**

Mural I

# EX.05.06

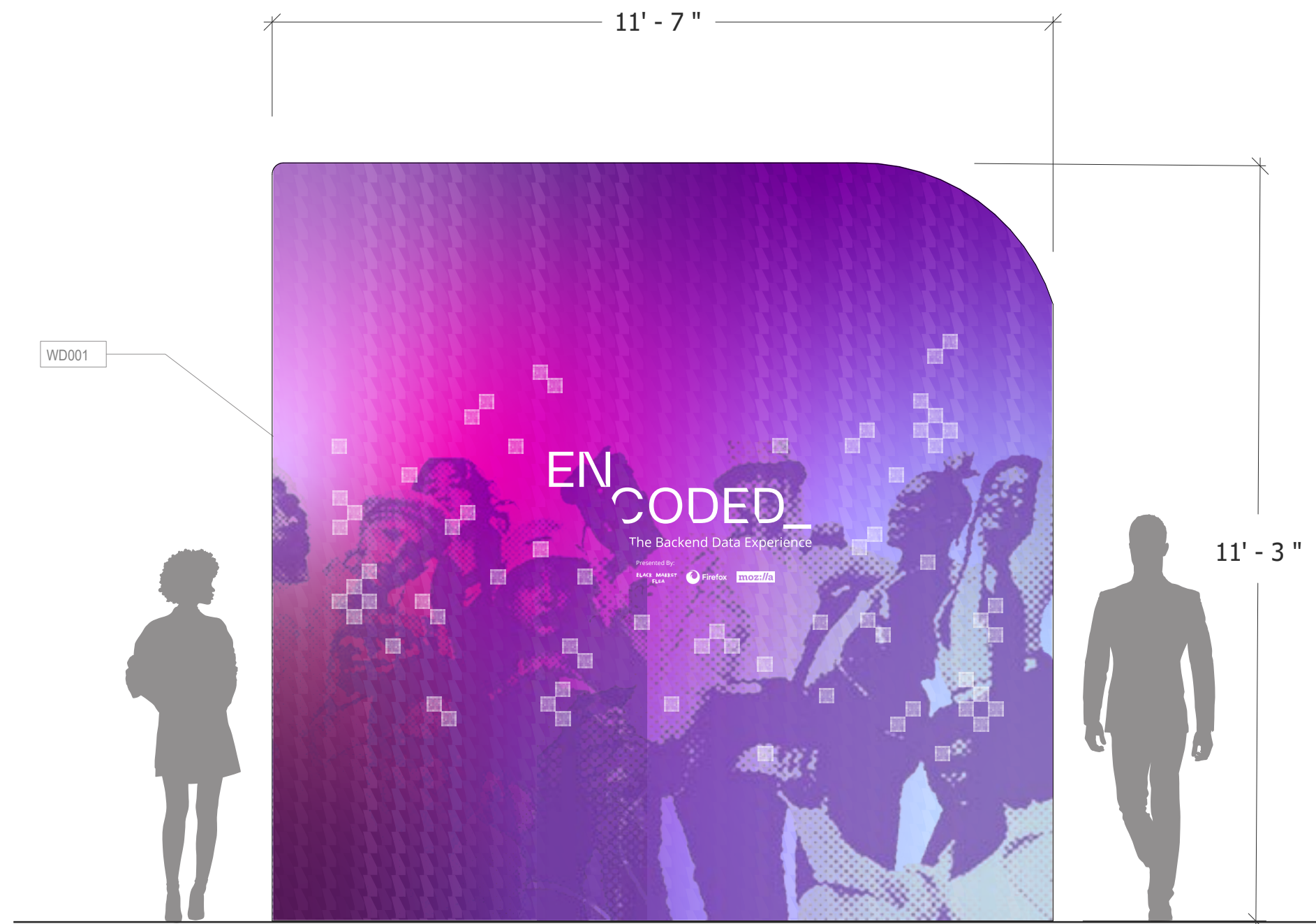

**1** C02.GR70 ELEVATION E  
Scale: 1/2" = 1'-0"

# LYKA WILLIAMS

Exhibition & Experience Design

## FASHION INSTITUTE OF TECHNOLOGY

School of Graduate Studies  
272 West 27th St  
New York, NY 10011

### PROJECT

**ENCODED\_**  
The Backend Data Experience

### CLIENT

**BLACK MARKET FLEA**

### PARTNERSHIP + SUPPORT



### DISCLAIMER

These drawings are not for construction. This is an unpublished and proprietary work protected under copyright, trade secret, and like laws of the United States and other countries. All rights reserved.

These materials may not be reproduced, displayed, distributed, nor may be the information therein be used or disclosed in whole or in part, without the express written permission of Marlyka Williams.

### KEY PLAN

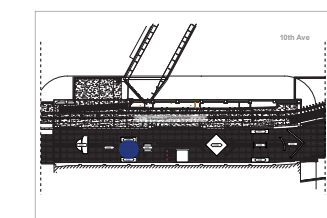

**DRAWN BY** MARLYKA WILLIAMS

**SCALE** 1/2" = 1'-0"

**DATE** December 09, 2022

**DRAWING NAME**

Mural II

# EX.05.07

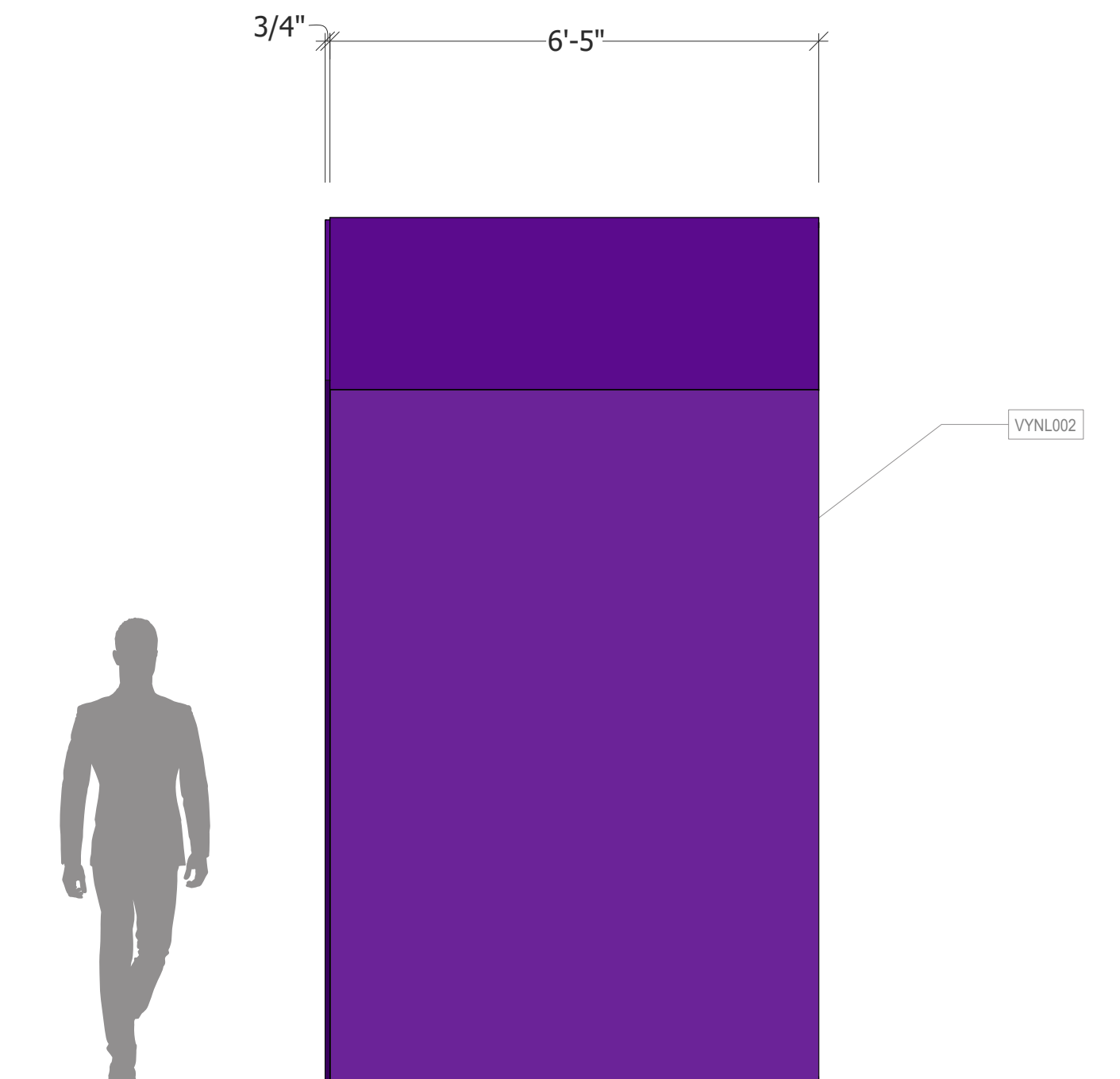

**1** C02.GR70 SIDE PROFILE E  
Scale: 1/2" = 1'-0"

# LYKA WILLIAMS

Exhibition & Experience Design

## FASHION INSTITUTE OF TECHNOLOGY

School of Graduate Studies  
272 West 27th St  
New York, NY 10011

### PROJECT

## ENCODED\_

The Backend Data Experience

### CLIENT

## BLACK MARKET FLEA

### PARTNERSHIP + SUPPORT



### DISCLAIMER

These drawings are not for construction. This is an unpublished and proprietary work protected under copyright, trade secret, and like laws of the United States and other countries. All rights reserved.

These materials may not be reproduced, displayed, distributed, nor may be the information therein be used or disclosed in whole or in part, without the express written permission of Marlyka Williams.

### KEY PLAN

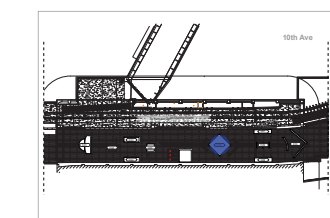

**DRAWN BY** MARLYKA WILLIAMS

**SCALE** NTS

**DATE** December 09, 2022

**DRAWING NAME**

Digital Media I

# EX.05.08

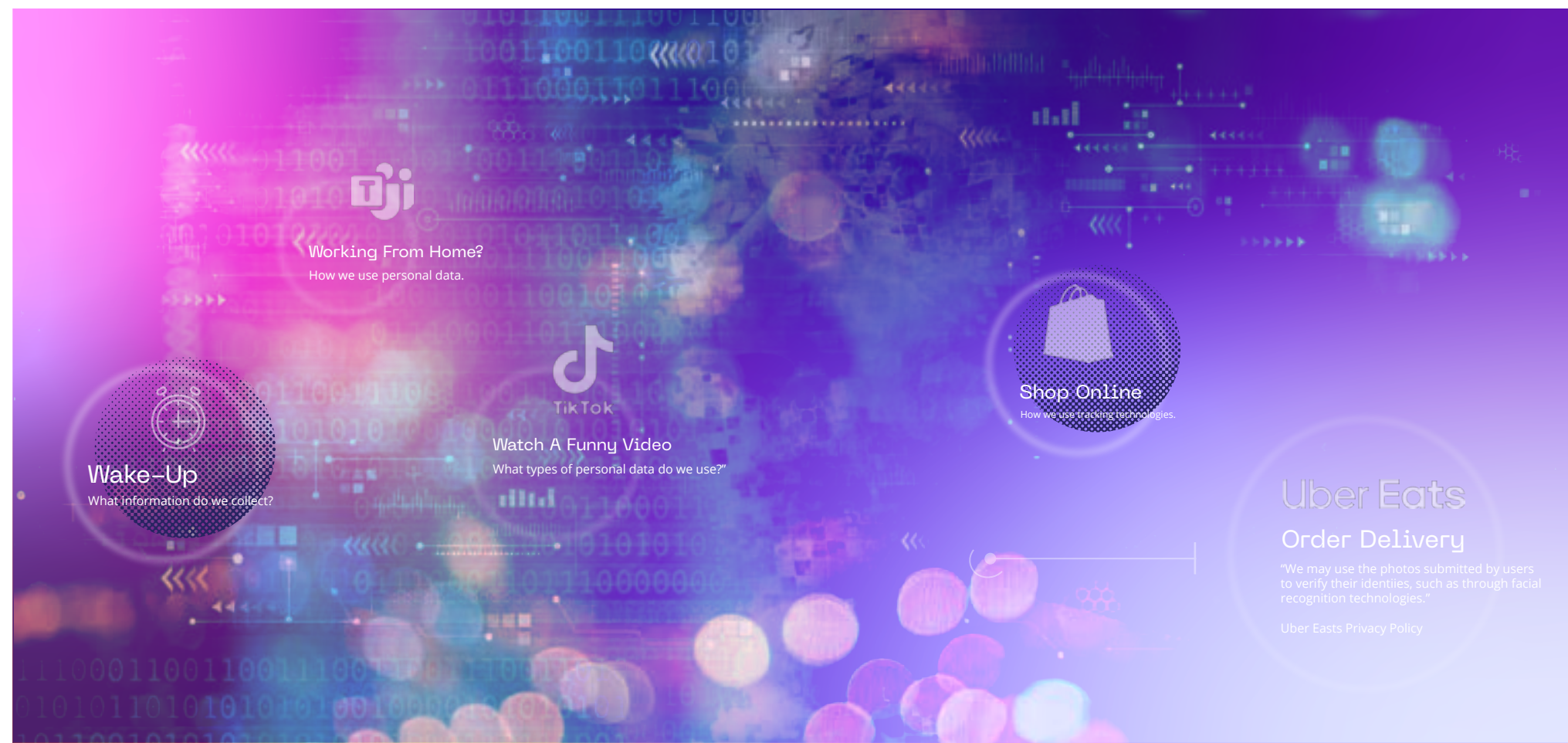





1 B02.GR74 XR DIGITAL GAME DISPLAY J  
Scale: NTS

**LYKA WILLIAMS**  
Exhibition & Experience Design

**FASHION INSTITUTE OF TECHNOLOGY**  
School of Graduate Studies  
272 West 27th St  
New York, NY 10011

**PROJECT**  
**ENCODED\_**  
The Backend Data Experience

**CLIENT**  
**BLACK MARKET FLEA**

**PARTNERSHIP + SUPPORT**  
Firefox mozilla

**DISCLAIMER**  
These drawings are not for construction. This is an unpublished and proprietary work protected under copyright, trade secret, and like laws of the United States and other countries. All rights reserved.  
These materials may not be reproduced, displayed, distributed, nor may be the information therein be used or disclosed in whole or in part, without the express written permission of Marlyka Williams.

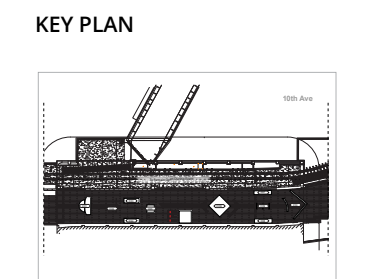

**DRAWN BY** MARLYKA WILLIAMS

**SCALE** NTS

**DATE** December 09, 2022

**DRAWING NAME**

Digital Media II

**EX.05.09**

# LYKA WILLIAMS

Exhibition & Experience Design

## FASHION INSTITUTE OF TECHNOLOGY

School of Graduate Studies  
272 West 27th St  
New York, NY 10011

### PROJECT

# ENCODED\_

The Backend Data Experience

### CLIENT

# BLACK MARKET FLEA

### PARTNERSHIP + SUPPORT



### DISCLAIMER

These drawings are not for construction. This is an unpublished and proprietary work protected under copyright, trade secret, and like laws of the United States and other countries. All rights reserved.

These materials may not be reproduced, displayed, distributed, nor may be the information therein be used or disclosed in whole or in part, without the express written permission of Marlyka Williams.

### KEY PLAN

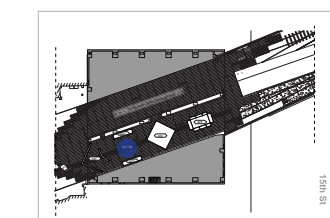

**DRAWN BY** MARLYKA WILLIAMS

**SCALE** 1/2" = 1'-0"

**DATE** December 09, 2022

**DRAWING NAME**

Labels I

# EX.05.10

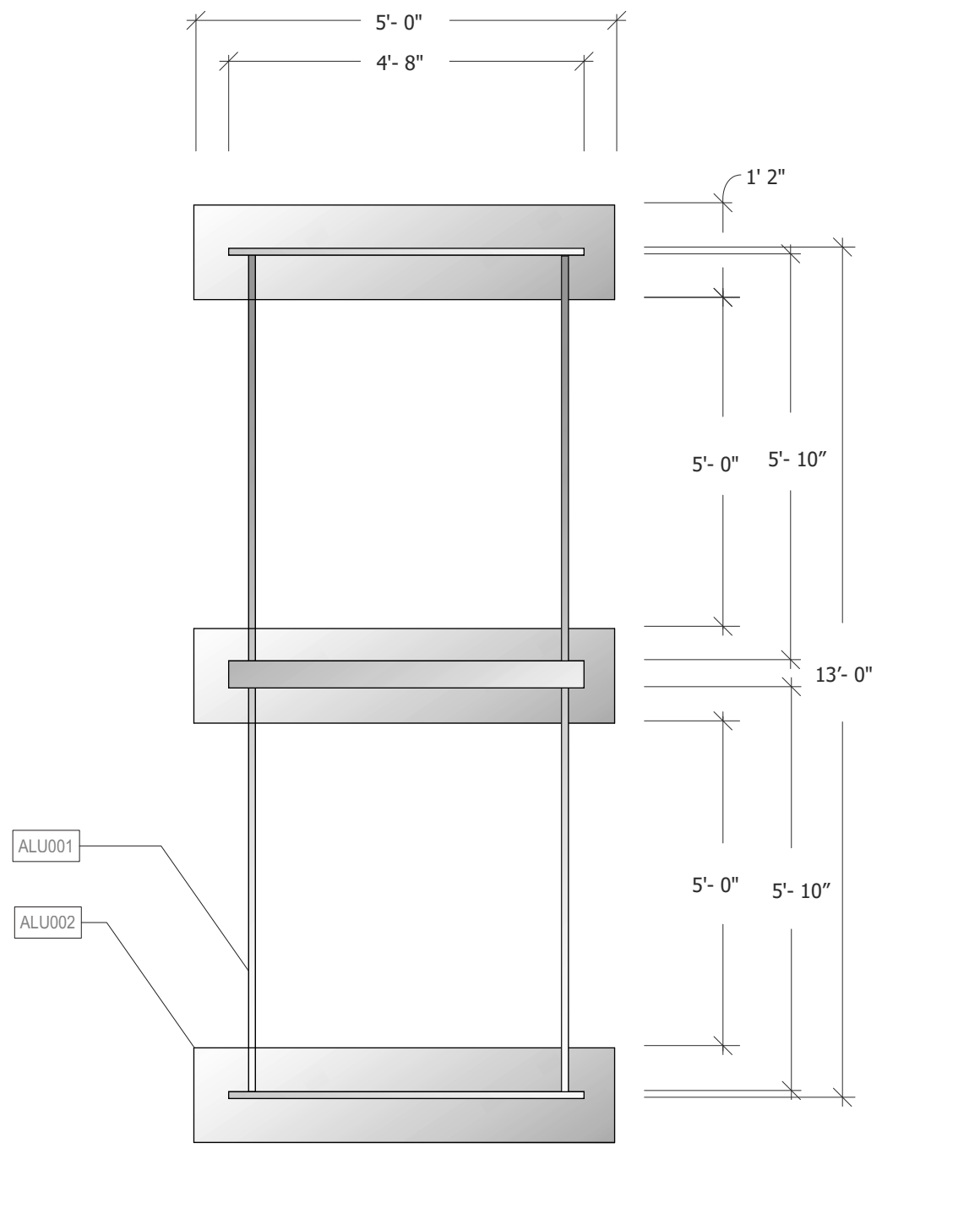

**1 A06 TOP VIEW**  
Scale: 1/2" = 1'-0"

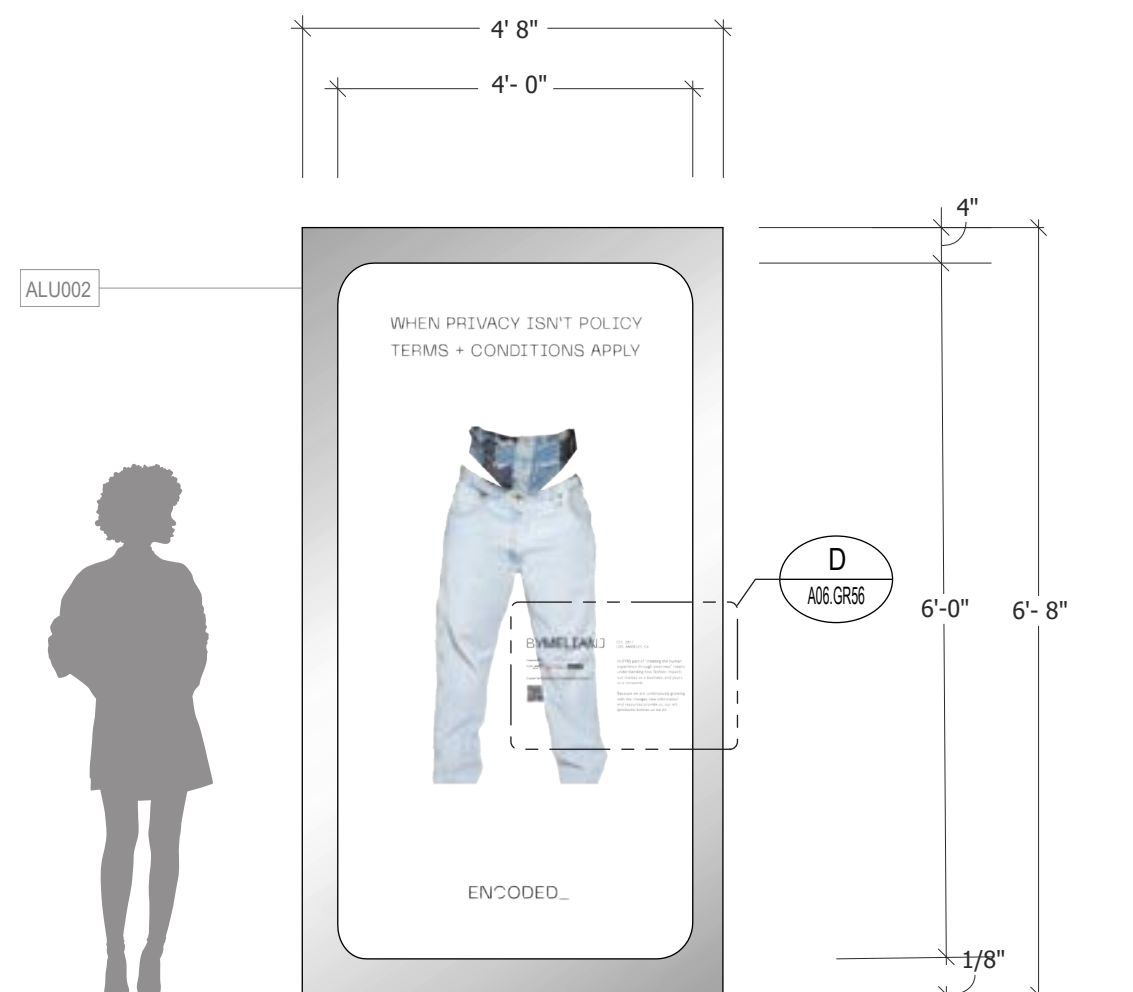

**2 A06.GR56 ELEVATION - PANEL B**  
Scale: 1/2" = 1'-0"

D

**PROJECT**

**ENCODED\_**  
The Backend Data Experience

**CLIENT**

**BLACK MARKET  
FLEA**

**PARTNERSHIP + SUPPORT**



**DISCLAIMER**

These drawings are not for construction. This is an unpublished and proprietary work protected under copyright, trade secret, and like laws of the United States and other countries. All rights reserved.

These materials may not be reproduced, displayed, distributed, nor may be the information therein be used or disclosed in whole or in part, without the express written permission of Marlyka Williams.

**KEY PLAN**

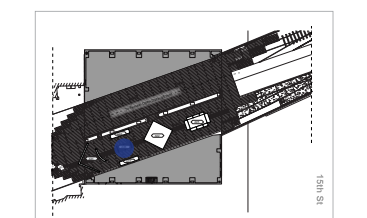

**DRAWN BY** MARLYKA WILLIAMS

**SCALE** 1/2" = 1'-0"

**DATE** December 09, 2022

**DRAWING NAME**

Labels II

**EX.05.11**

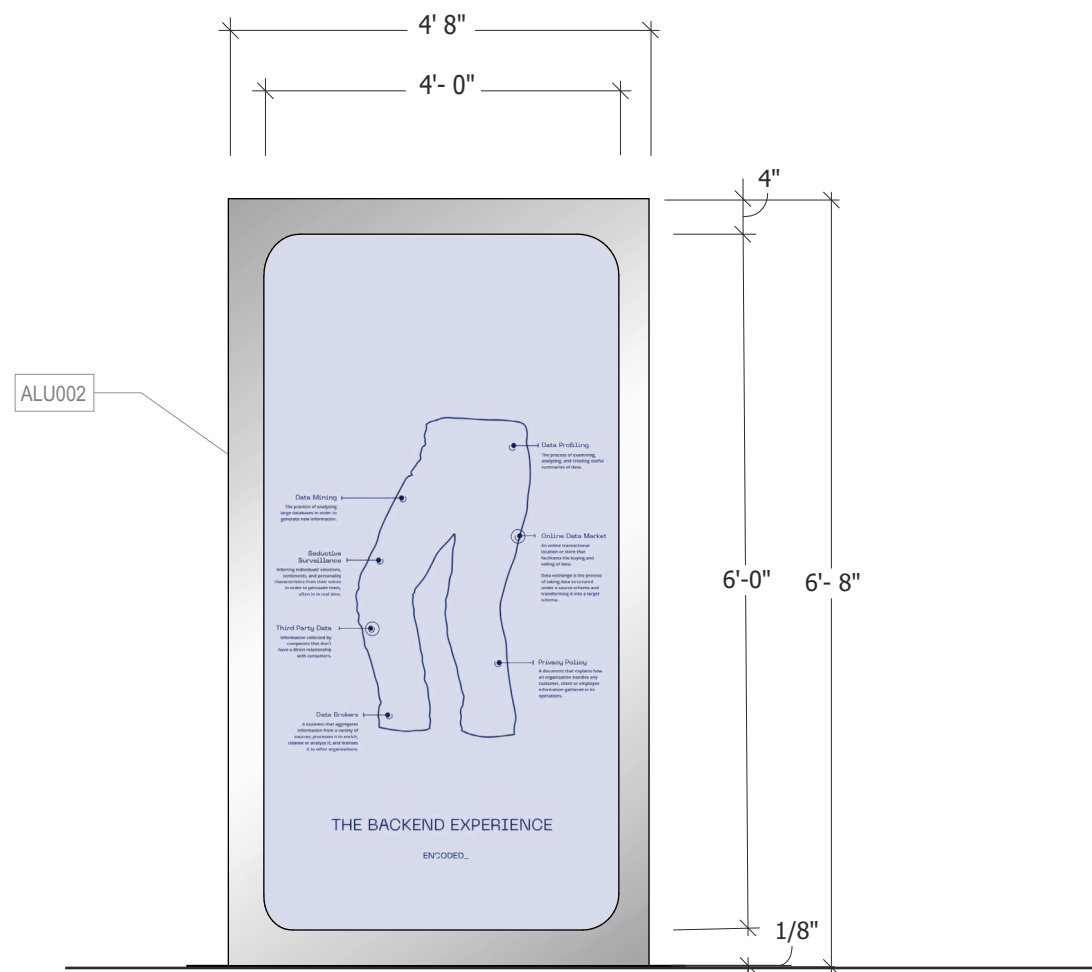

**1** A06.GR15 ELEVATION - PANEL A **B**  
Scale: 1/2" = 1'-0"

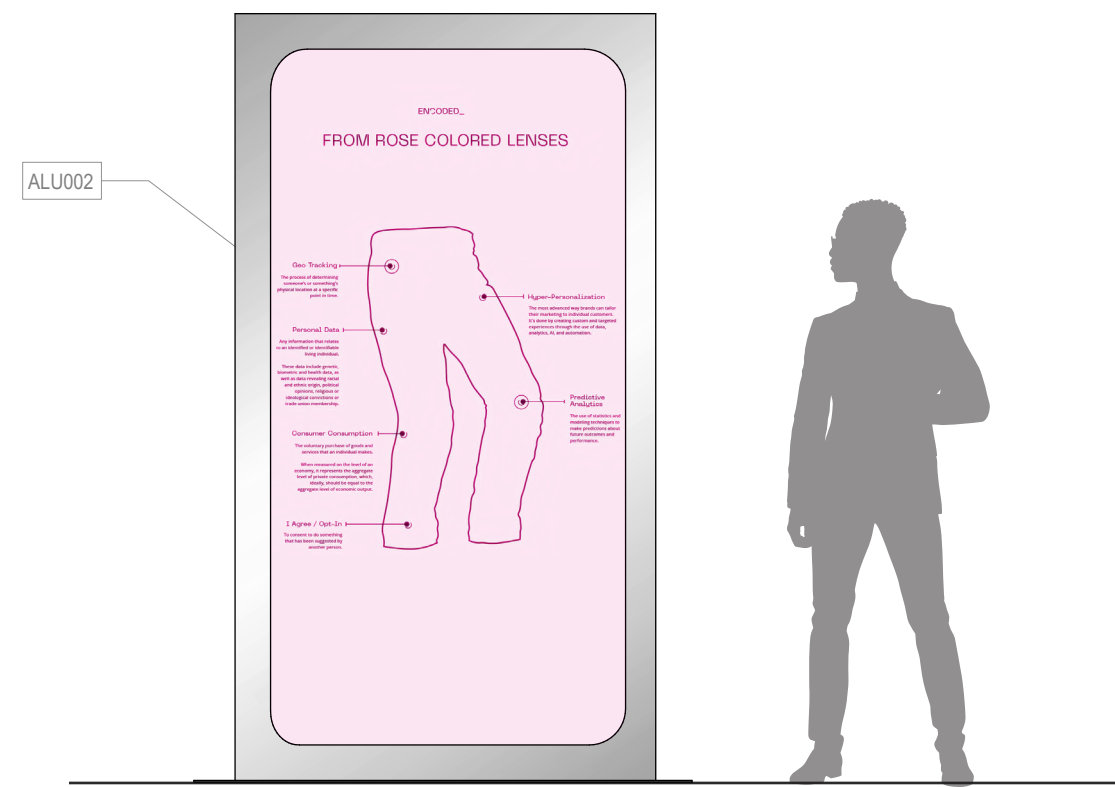

**2** A06.GR16 ELEVATION - PANEL C **C**  
Scale: 1/2" = 1'-0"



DISCLAIMER

These drawings are not for construction. This is an unpublished and proprietary work protected under copyright, trade secret, and like laws of the United States and other countries. All rights reserved.

These materials may not be reproduced, displayed, distributed, nor may be the information therein be used or disclosed in whole or in part, without the express written permission of Marlyka Williams.

KEY PLAN

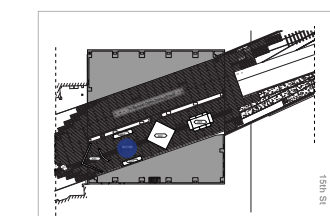

DRAWN BY MARLYKA WILLIAMS

SCALE 1/2" = 1'-0"

DATE December 09, 2022

DRAWING NAME

Labels III

EX.05.12

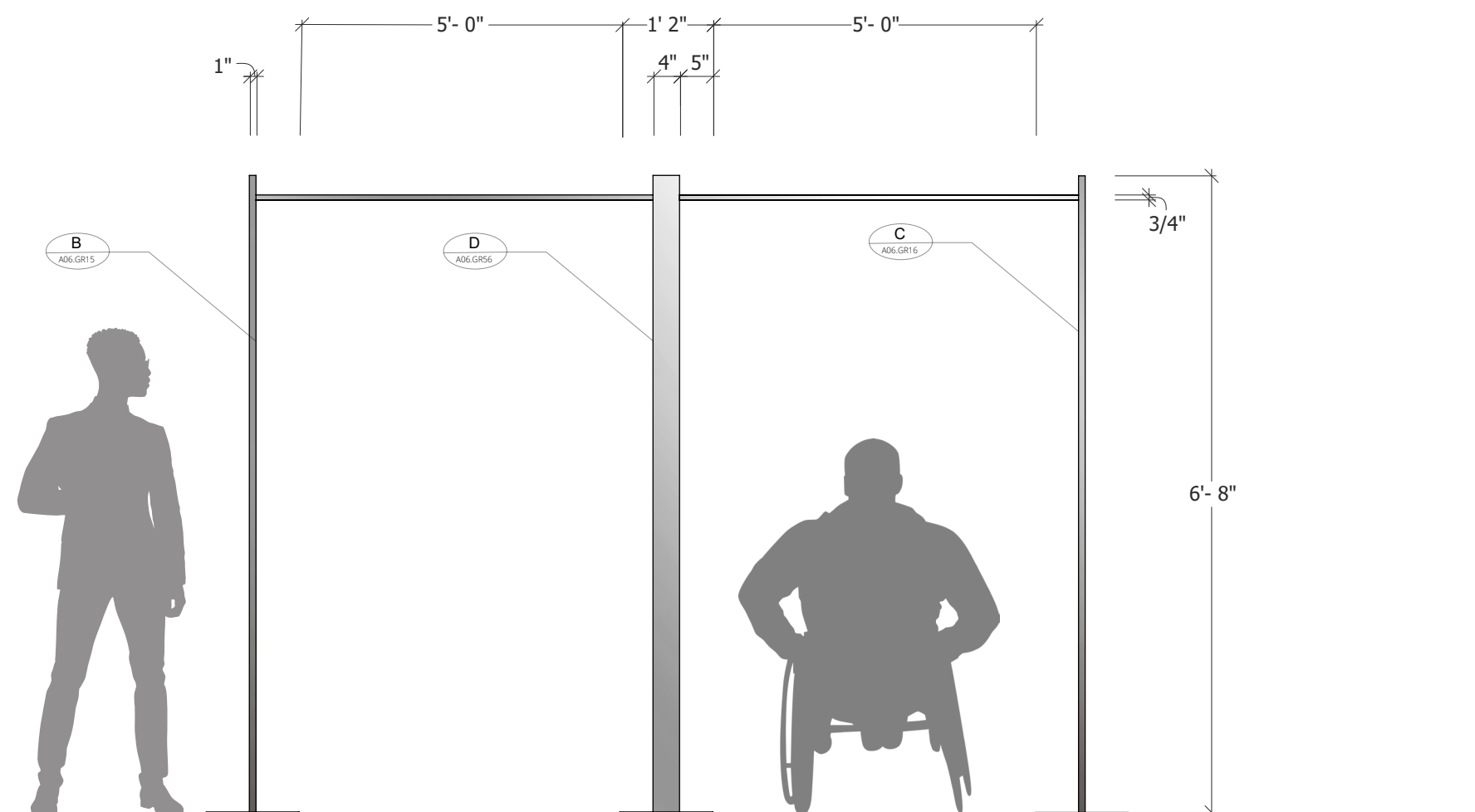

1 A06 SIDE PROFILE  
Scale: 1/2" = 1'-0"



These drawings are not for construction. This is an unpublished and proprietary work protected under copyright, trade secret, and like laws of the United States and other countries. All rights reserved.

These materials may not be reproduced, displayed, distributed, nor may be the information therein be used or disclosed in whole or in part, without the express written permission of Marlyka Williams.

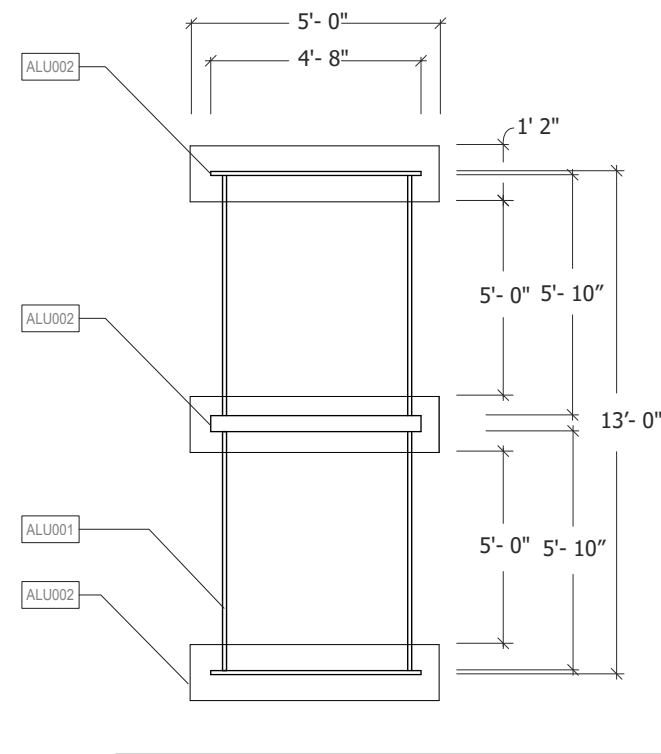
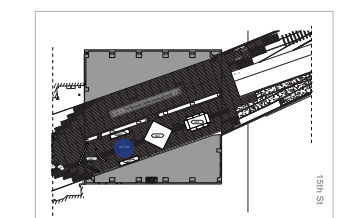

**1 A06 FLOORPLAN**  
Scale: 1/4" = 1'-0"

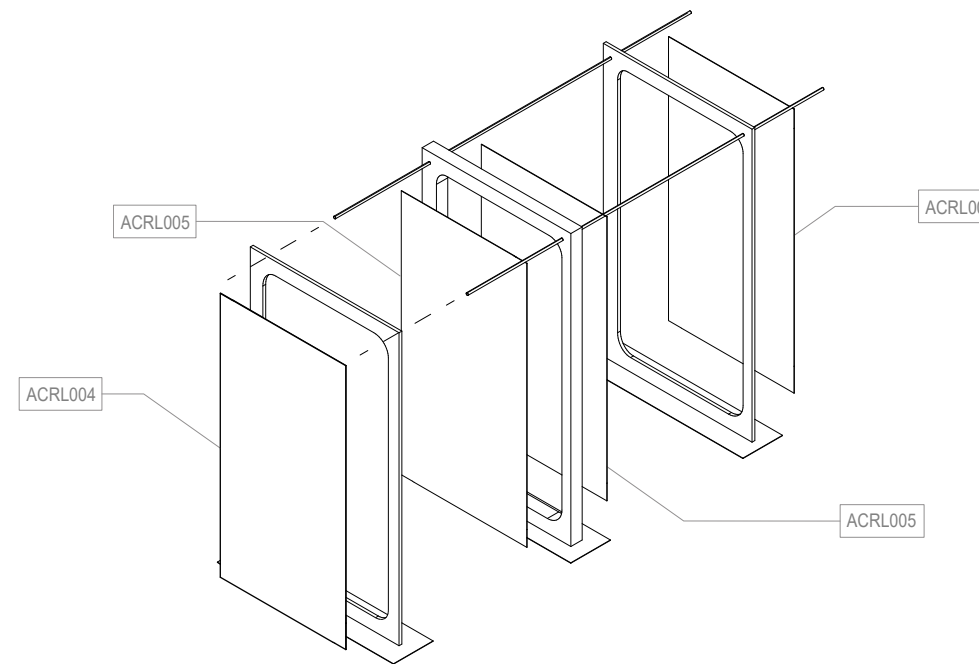

**1 A06 ISOMETRIC VIEW**  
Scale: 1/4" = 1'-0"

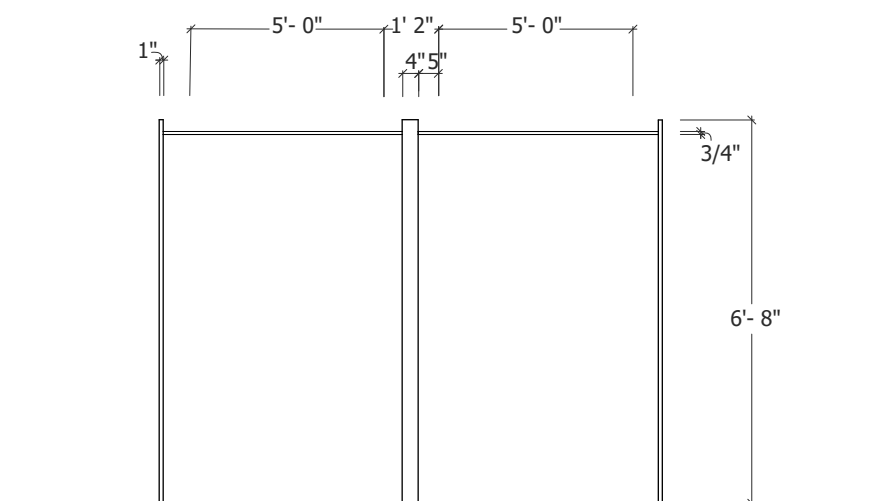

**1 A06 SIDE ELEVATION**  
Scale: 1/4" = 1'-0"

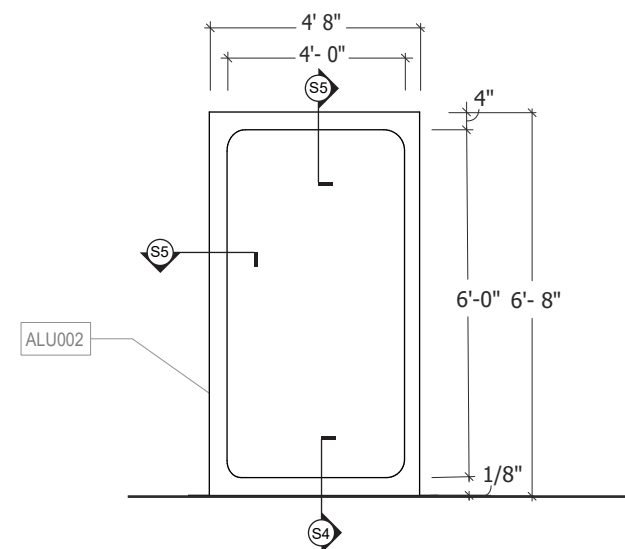

**1 A06 FRONT ELEVATION**  
Scale: 1/4" = 1'-0"



**DISCLAIMER**

These drawings are not for construction. This is an unpublished and proprietary work protected under copyright, trade secret, and like laws of the United States and other countries. All rights reserved.

These materials may not be reproduced, displayed, distributed, nor may be the information therein be used or disclosed in whole or in part, without the express written permission of Marlyka Williams.

**KEY PLAN**

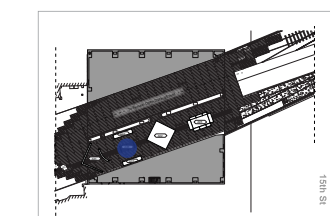

**DRAWN BY** MARLYKA WILLIAMS

**SCALE** 1/4" = 1'-0"

**DATE** December 09, 2022

**DRAWING NAME**

A06, C09 Technical Detail II

**EX.05.14**

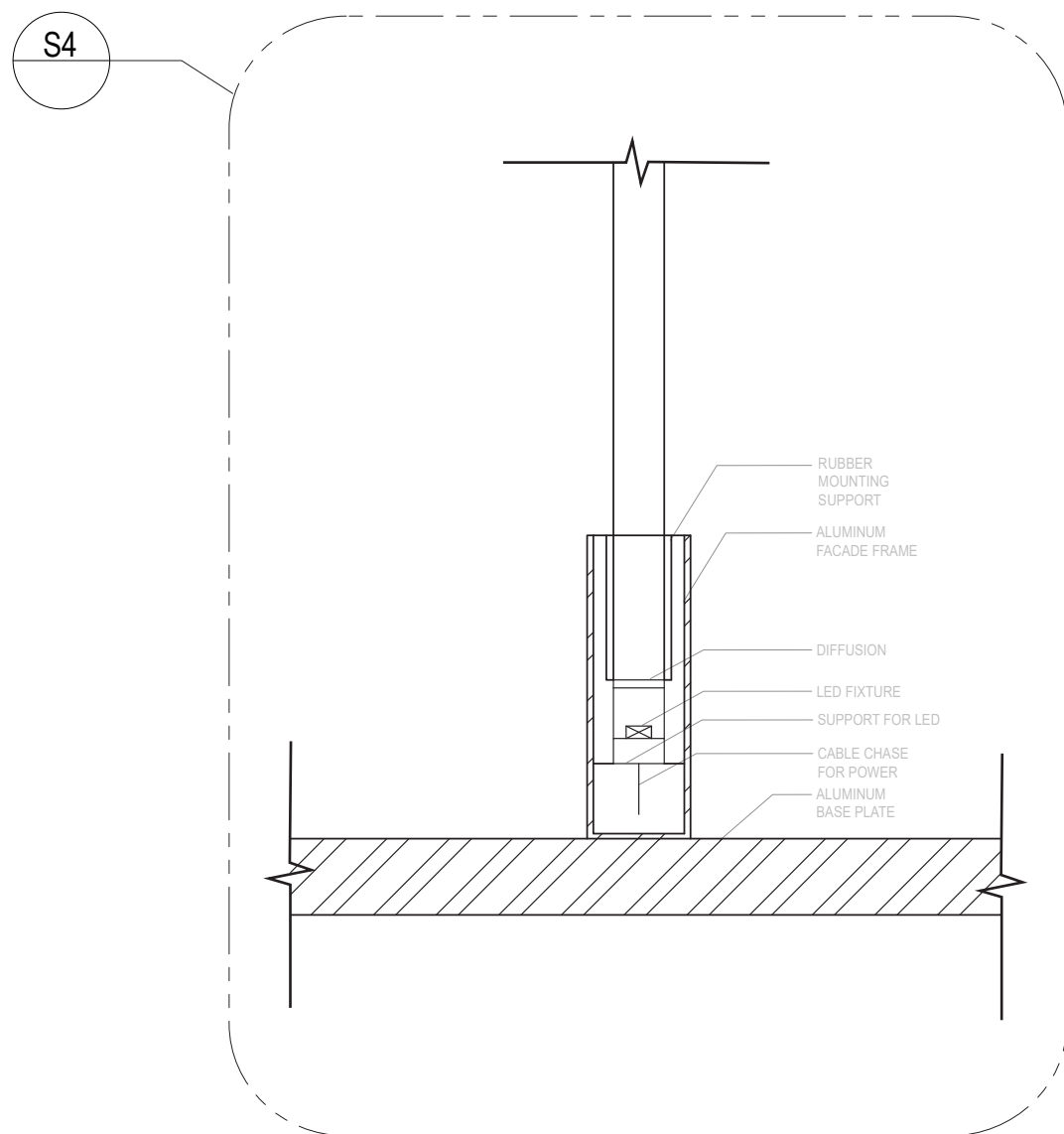

**1 S4 SECTION DETAIL**  
Scale: NTS

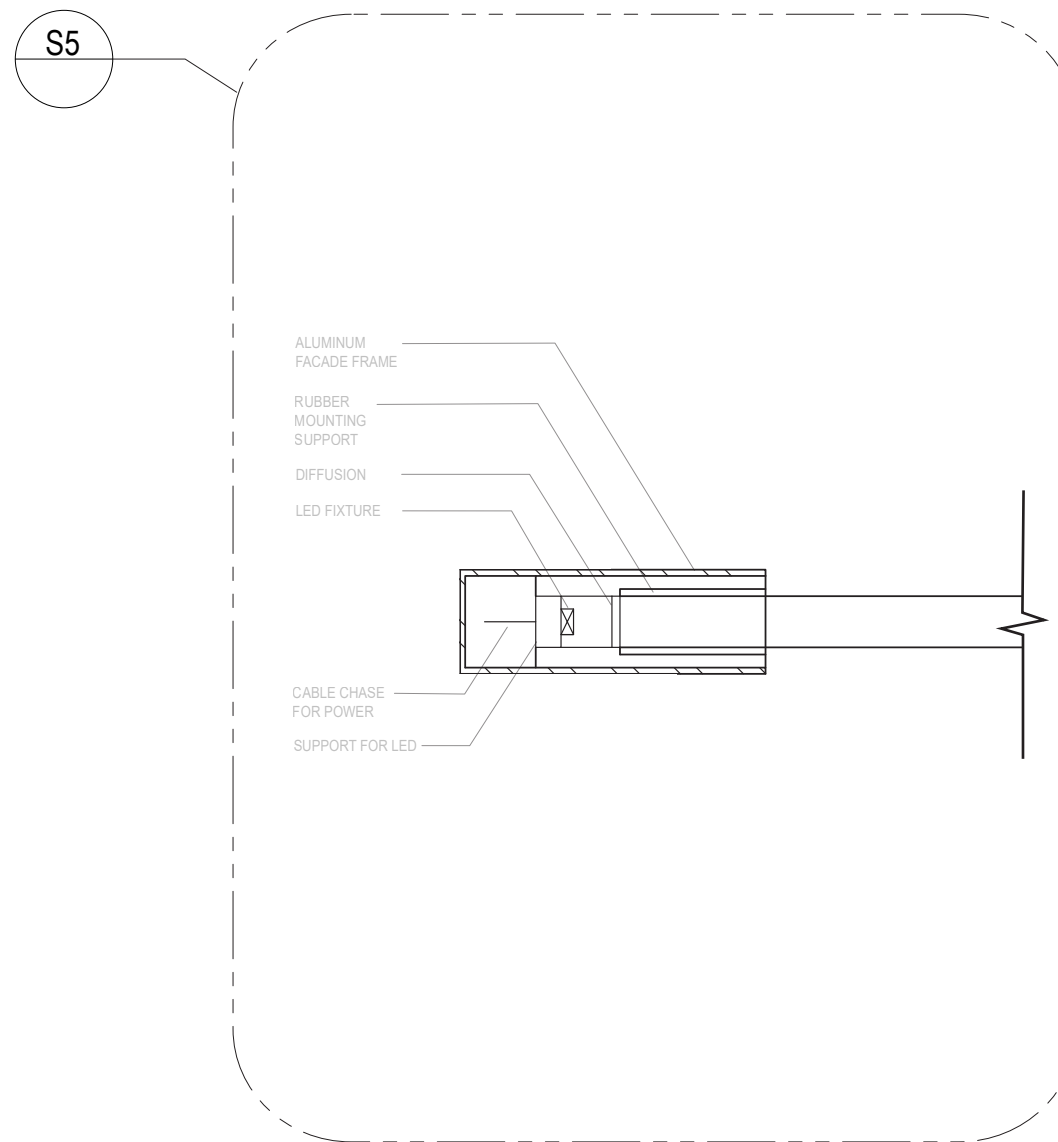

**2 S5 SECTION DETAIL**  
Scale: NTS

# LYKA WILLIAMS

Exhibition & Experience Design

## FASHION INSTITUTE OF TECHNOLOGY

School of Graduate Studies  
272 West 27th St  
New York, NY 10011

### PROJECT

## ENCODED\_

The Backend Data Experience

### CLIENT

## BLACK MARKET FLEA

### PARTNERSHIP + SUPPORT



### DISCLAIMER

These drawings are not for construction. This is an unpublished and proprietary work protected under copyright, trade secret, and like laws of the United States and other countries. All rights reserved.

These materials may not be reproduced, displayed, distributed, nor may be the information therein be used or disclosed in whole or in part, without the express written permission of Marlyka Williams.

### KEY PLAN

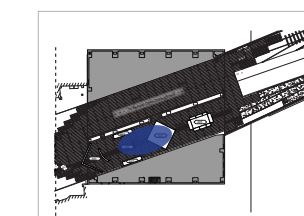

DRAWN BY MARLYKA WILLIAMS

SCALE NTS

DATE December 09, 2022

### DRAWING NAME

A06 + A02 Physical Model I

# EX.05.15



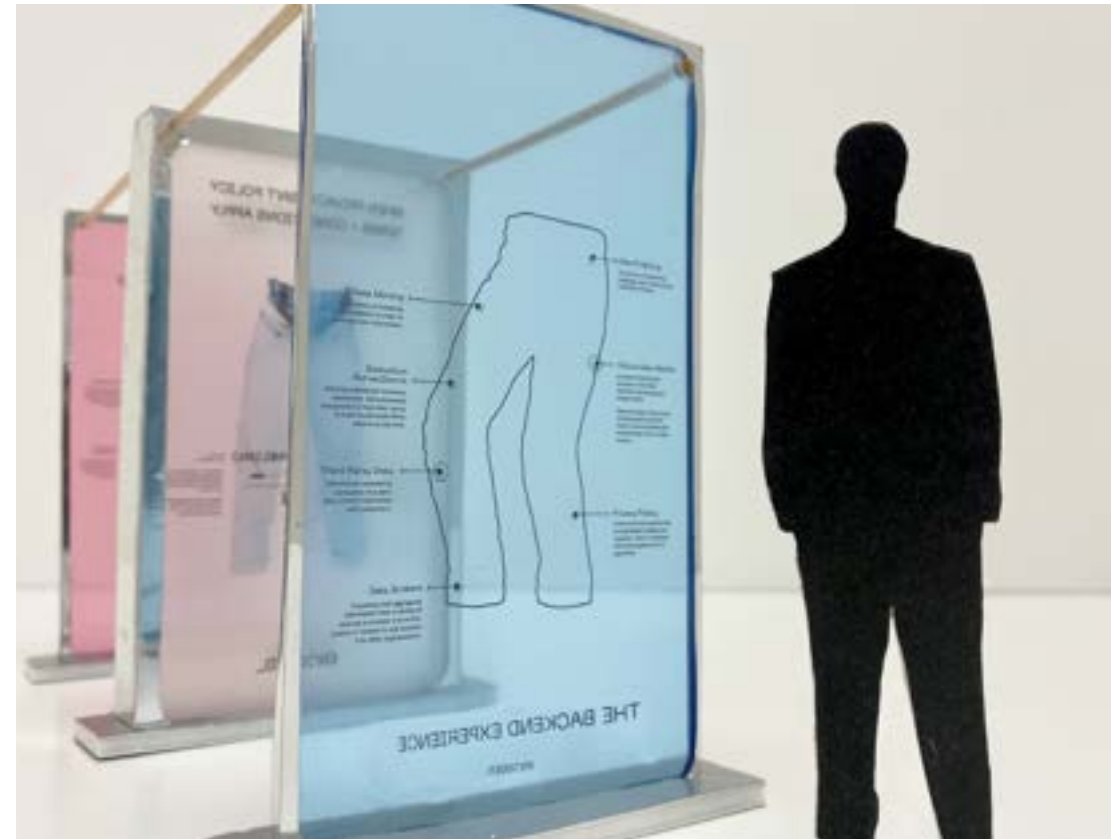

# LYKA WILLIAMS

Exhibition & Experience Design

## FASHION INSTITUTE OF TECHNOLOGY

School of Graduate Studies  
272 West 27th St  
New York, NY 10011

### PROJECT

## ENCODED\_

The Backend Data Experience

### CLIENT

## BLACK MARKET FLEA

### PARTNERSHIP + SUPPORT



### DISCLAIMER

These drawings are not for construction. This is an unpublished and proprietary work protected under copyright, trade secret, and like laws of the United States and other countries. All rights reserved.

These materials may not be reproduced, displayed, distributed, nor may be the information therein be used or disclosed in whole or in part, without the express written permission of Marlyka Williams.

### KEY PLAN

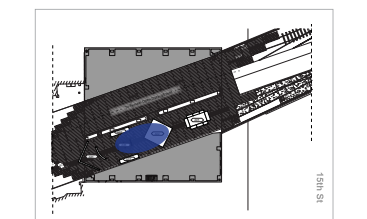

DRAWN BY MARLYKA WILLIAMS

SCALE NTS

DATE December 09, 2022

DRAWING NAME

A06 + A02 Physical Model II

# EX.05.16



# LYKA WILLIAMS

Exhibition & Experience Design

## FASHION INSTITUTE OF TECHNOLOGY

School of Graduate Studies  
272 West 27th St  
New York, NY 10011

### PROJECT

## ENCODED\_

The Backend Data Experience

### CLIENT

## BLACK MARKET FLEA

### PARTNERSHIP + SUPPORT



### DISCLAIMER

These drawings are not for construction. This is an unpublished and proprietary work protected under copyright, trade secret, and like laws of the United States and other countries. All rights reserved.

These materials may not be reproduced, displayed, distributed, nor may be the information therein be used or disclosed in whole or in part, without the express written permission of Marlyka Williams.

### KEY PLAN

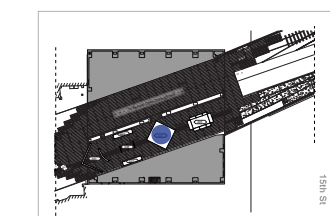

DRAWN BY MARLYKA WILLIAMS

SCALE NTS

DATE December 09, 2022

DRAWING NAME

A02 Physical Model I

# EX.05.17



This Design Development Package was created  
By Marlyka Williams

In partial fulfillment of the requirements for the degree of  
**MASTER OF ARTS IN EXHIBITION AND EXPERIENCE DESIGN**

December 2022

Michele Washington, Advisor

Peter Hyde, Professor  
Brenda Cowan, Professor  
Ted Nordlander, Professor

Christina Lyons, Chairperson

Dr. Brooke Carlson, Interim Dean, School of Graduate Studies

# ENCODED\_

The Backend Data Experience

**DESIGN DEVELOPMENT PACKAGE**

**GRADUATE THESIS**  
MA EXHIBITION AND EXPERIENCE DESIGN  
FASHION INSTITUTE OF TECHNOLOGY

**LYKA WILLIAMS**

Copyright © 2022 by Marlyka Williams  
All Rights Reserved.